

8 Series

meeknet.co.uk

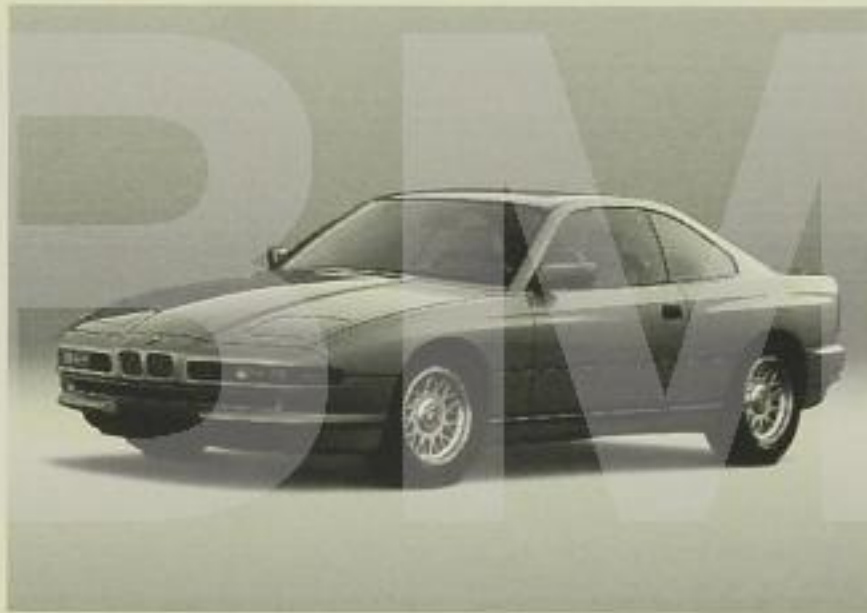

Owner's Handbook



Copyright © 2000 Hewlett-Packard Company

The information on this page is provided for informational purposes only. It is not intended to be used as a substitute for the actual product.

The information on this page is provided for informational purposes only. It is not intended to be used as a substitute for the actual product.

For more information, visit us online at www.hp.com

- 840Ci**
- 850Ci**
- 850CSi**

840C1
820C1
820C21

Congratulations on your choice of a BMW.

The better you are acquainted with your car, the easier you will discover driving it to be. We would therefore like to offer you the following advice.

This Owner's Handbook contains important information on operating and looking after your BMW. It contains important hints on correct operation on the controls, so that you benefit fully from your BMW's many advanced technical features. There are also full details of maintenance and general care, with the aim of keeping your car fully operational and safe at all times, and maintaining its value.

Wishing you many an enjoyable and safe journey.

BMW AG

Before you read this Owner's Handbook, here are some important items of information:

When you purchased the vehicle, you chose a specific model and a range of equipment to suit your preferences. This handbook describes all the models and equipment developed by BMW within its 8 Series.

Right-hand-drive cars may have controls and equipment located in different places from those described here.

Refer to the keyword index as a rapid means of finding the topic you need.

Descriptions of items of equipment not found in this handbook are given in the installation or operating instructions accompanying such items. Your BMW Service station will gladly advise you.

We have used the following symbols in the pages of this handbook:



indicates information which you should definitely have read for your own safety and to protect your car against damage or defects. ◀



is used to identify details of special features. ◀

* identifies optional extras or specific national-market items of equipment, and also accessories.



refers to recycling methods or procedures. ◀

If you have any queries, BMW Service will be glad to advise you.

© 1996 BMW AG
Munich, Germany
Not to be reproduced wholly or in part without written permission from BMW AG, Munich.
Order No. 01 41 9 790 191
English IV/96
Printed in Germany
Printed on environmentally friendly paper (bleached without chlorine, suitable for recycling)



Important safety information: for your own safety, always use parts and accessories which have been approved by BMW.

Parts approved by BMW have been tested for safety, function and suitability for use on BMW vehicles. BMW accepts product liability for parts it has approved.

BMW is unable to accept any form of liability for parts, accessories or other products which it has not approved.

BMW clearly cannot assess every product of outside origin in order to ensure that it represents no risk of injury to the user if installed or operated with a BMW automobile. Nor can approval by an official technical inspection authority for the issue of a general operating permit by a government body provide absolute assurance that a product is entirely suitable, since the tests performed by such bodies tend to be of a more general nature only.

Original BMW Parts and Accessoires and other products approved by BMW are available from BMW Service, which will gladly provide competent advice on all related matters.

The functional efficiency and road safety of your BMW, and its resale value, may be adversely affected if changes not in accordance with its general operating permit or the manufacturer's specification are made to its equipment.

All dimensions, weights and performance data stated in this Owner's Handbook are in accordance with the relevant German Industrial Standards (DIN) and the tolerances laid down for them. National-market versions may differ from those described here.

Fuel consumption figures are as determined at the time of closing for press.

The high safety and quality standards of BMW vehicles are upheld by ongoing development in the design, equipment and accessories areas. This may give rise to discrepancies between the contents of this Owner's Handbook and your own vehicle. Nor can errors and omissions be entirely ruled out. You are therefore asked to appreciate that no legal claims can be entertained in respect of the data, illustrations or descriptions quoted here.

Important facts to know

Controls

Operating hints

Care and maintenance

Technical data

Index

- Cockpit 12
- Instrument cluster 14
- Telltale and warning lights 16
- Distance recorder 18
- Revolution counter 18
- Fuel gauge 19
- Coolant thermometer 19
- Ignition-starter switch/steering lock 20
- Starting the engine 21
- Stopping the engine 21
- Running in 22
- Refuelling 23
- Fuel grades 23
- Tyre pressures 24

- Electronic immobilizer 26
- Keys 26
- Doors 27
- Luggage compartment 29
- Radio remote control 30
- Alarm system 34
- Seats 36
- Steering wheel adjustment 38
- Electric steering wheel adjustment 39
- Mirrors 40
- Seat, mirror and steering wheel position memory 42
- Seat belts 42
- Airbags 44
- Light switch 45
- Fog light switch 46
- Turn indicators/dipped beams 46
- Hazard warning flashers 47
- Interior light/footwell lights 47
- Headlight beam throw adjustment 48
- Wipers/washer 48
- Window lifts 50
- Sliding/tilt sunroof 51
- Multi-Information Display (MID) 52
- Service Interval indicator 53
- Digital clock 54
- On-board computer 56
- Check Control 64
- Handbrake 67
- EML 68

- Manual gearbox 68
- Automatic transmission with STEPTRONIC 69
- Cruise control 72
- EDC 73
- ASC+T 73
- DSC 74
- Automatic air conditioning 76
- Heated rear window 81
- Independent heater 82
- Independent ventilation control 82
- Roller sunblind 83
- Glove box 83
- Ashtrays 84
- Rear seat backs 85
- Ski bag 85

- Driving hints 88
- Car radio operation 89
- Car phone 89
- Engine compartment lid 90
- Vehicle identification 91
- Type plate 91
- Engine compartment, BMW 840Ci 92
- Engine compartment, BMW 850Ci, 850CSi 94
- Engine oil 96
- Hydraulics and ARK 98
- Brake fluid 99
- Coolant 100
- Washer fluid for cleaning systems 101
- Jets 102
- Power steering 103
- Brake system 103
- Batteries 104
- Fuses 106
- Toolkit 107
- Warning triangle 107
- Fire extinguisher 107
- First aid kit 108
- Tow-starting, towing away 108
- Tow-starting 109
- Towing away 109
- Starting with flat battery 110
- Wheel-changing 111
- Lockable wheel studs 114
- Fuel filler flap 114

- Luggage compartment 115
- Sliding-tilt sunroof 115
- Headlights 115
- Wiper blades, changing 116
- Bulb-changing 117
- Winter operation 122
- Towing a trailer 123
- Roof rack 126
- Rule of the road 126
- Licensing abroad 127
- ABS 127
- Active Rear-axle Kinematics (ARK) 129
- Disc brakes 130
- Tyre pressures 131
- Tyre tread 131
- New and retreaded tyres 132
- Interchanging wheels 132
- Correct choice of wheels and tyres 133
- Winter tyres 134
- Approved wheels and tyres 135
- Technical modifications 136

- The BMW Maintenance System 138
- Care of the car 139
- Laying up out of use 144

Contents

Technical data

- Engine data 146
- Fuel consumption, carbon dioxide (CO₂) emissions 147
- Dimensions 148
- Weights 149
- Performance 150
- Filling capacities 151
- Electrical system 152
- V-belts 152

Index

- From A to Z 154

Driving area

- 1. How to handle the vehicle
- 2. Getting started
- 3. Driving
- 4. Stopping
- 5. Parking
- 6. Driving at night
- 7. Driving in the rain
- 8. Driving in winter
- 9. Driving in summer
- 10. Driving in hilly areas
- 11. Driving in mountainous areas
- 12. Driving in snowy areas
- 13. Driving in icy areas
- 14. Driving in fog
- 15. Driving in low visibility
- 16. Driving in heavy traffic
- 17. Driving in narrow roads
- 18. Driving in roundabouts
- 19. Driving in junctions
- 20. Driving in roundabouts
- 21. Driving in roundabouts
- 22. Driving in roundabouts
- 23. Driving in roundabouts
- 24. Driving in roundabouts
- 25. Driving in roundabouts
- 26. Driving in roundabouts
- 27. Driving in roundabouts
- 28. Driving in roundabouts
- 29. Driving in roundabouts
- 30. Driving in roundabouts

- Cockpit 12
- Instrument cluster 14
- Telltale and warning lights 16
- Distance recorder 18
- Revolution counter 18
- Fuel gauge 19
- Coolant temperature gauge 19
- Ignition/starter switch and steering lock 20
- Starting the engine 21
- Stopping the engine 21
- Running in 22
- Refuelling 23
- Tyre pressures 24

Important facts in brief

- Controls
- Operating hints
- Care and maintenance
- Technical data
- Index

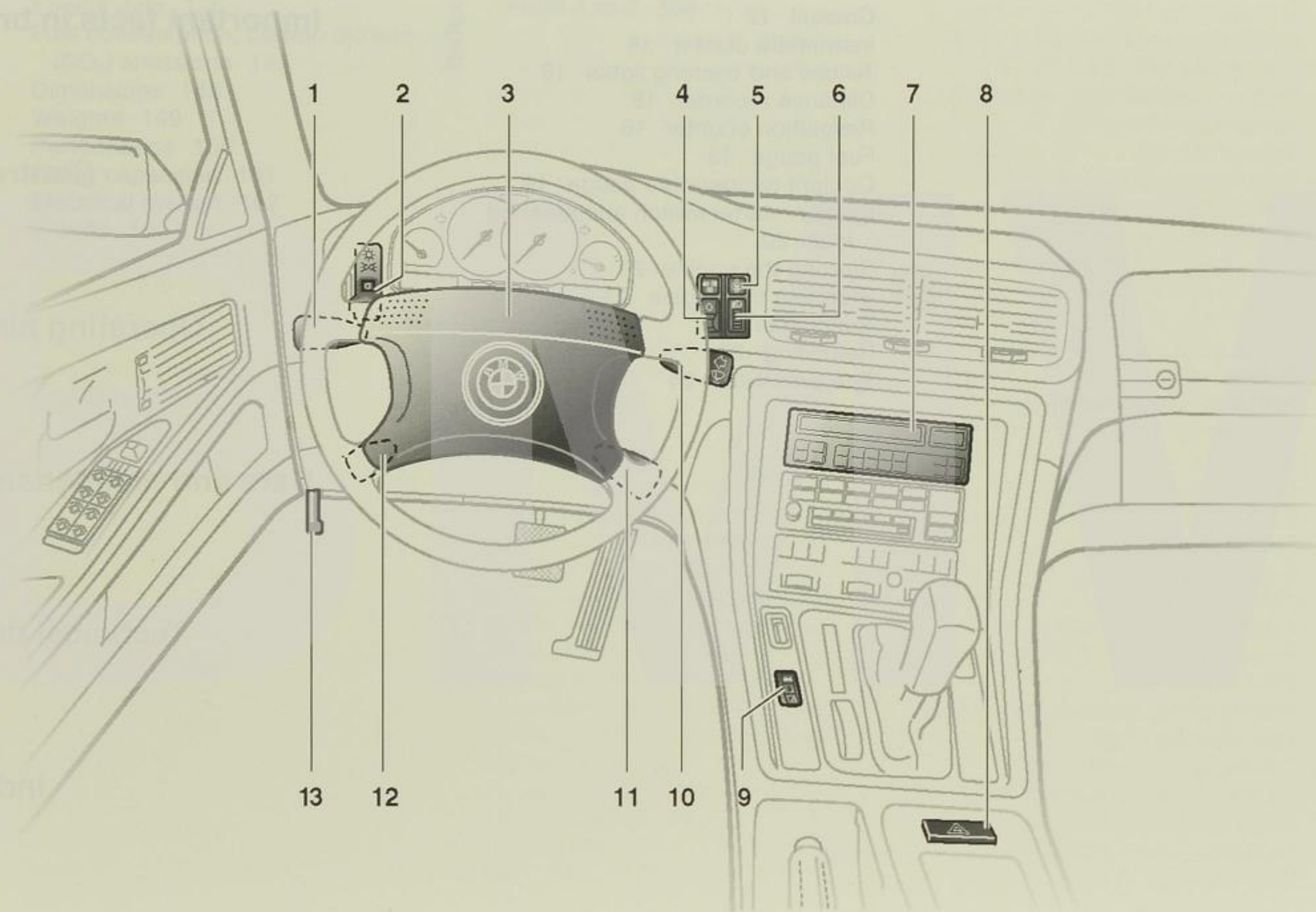

312de002

- 1 Lever for flashing turn indicators, parking lights, dipped headlights and headlight flasher 46
- 2 Main light switch 45
- 3 Horn, entire surface
- 4 Fog light switch 46
- 5 Switch for heated rear window 81
- 6 Knurled wheel for headlight beam throw adjustment 48
- 7 Multi-Information Display (MID) 52
- 8 Switch for hazard warning flashers 47
- 9 Switch for programmable electronic output control (EML) (BMW 850CSi only) 68
- 10 Wipe/wash control lever 48
- 11 Cruise control lever 72
- 12 Lever for electric steering-wheel adjustment 39
- 13 Engine compartment release lever 90

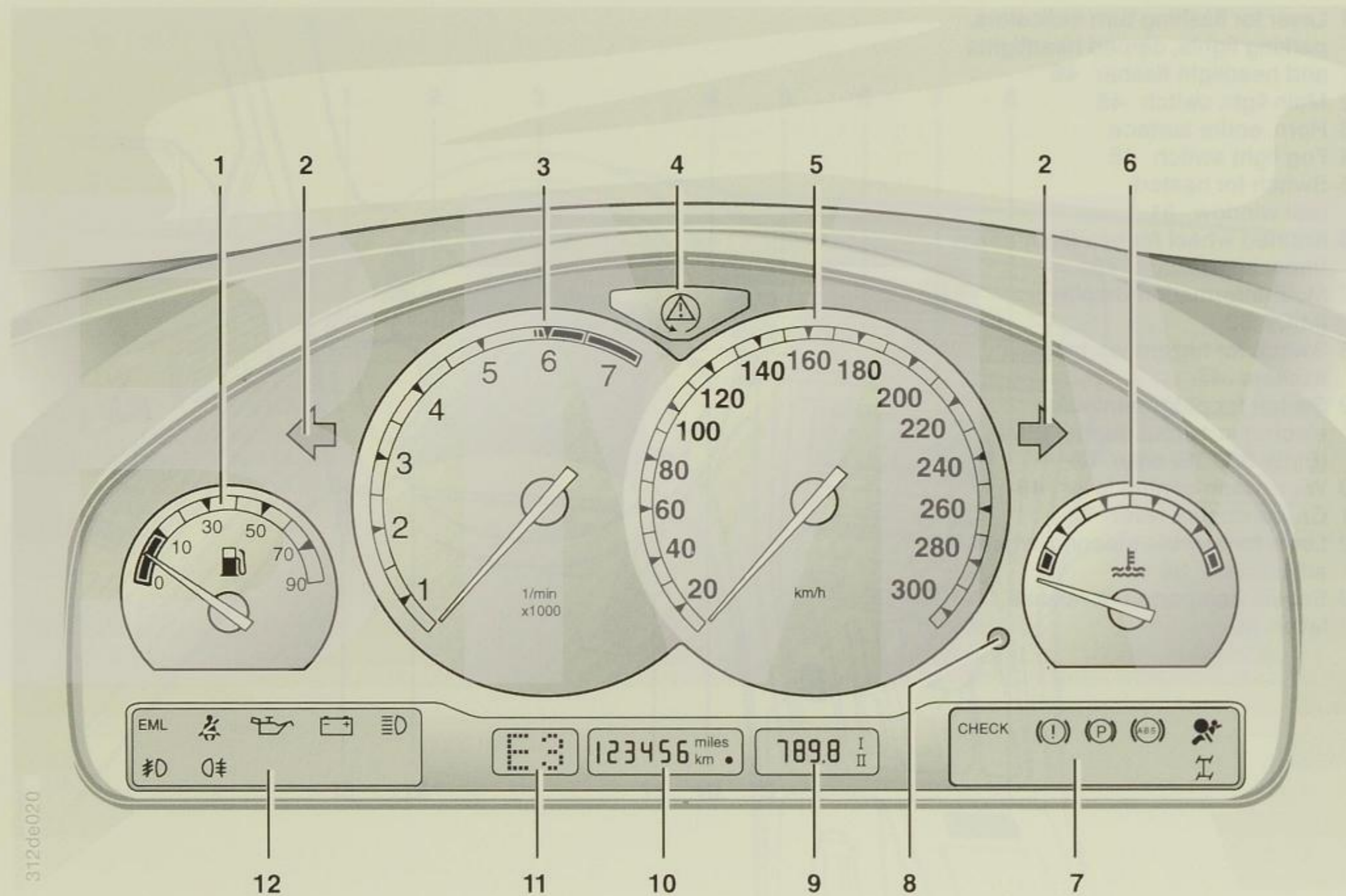

312de020

- 1 Fuel gauge with warning light for reserve supply 19
- 2 Turn indicator repeaters 16
- 3 Revolution counter 18
- 4 Telltale light for ASC+T/DSC 16
- 5 Speedometer
- 6 Coolant temperature gauge 19
- 7 Check control indicator light and telltale and warning lights for brake system and steering hydraulics, handbrake, ABS, AIRBAG, AHK and trailer flashing turn indicators 64, 17
- 8 Trip distance reset knob and changeover knob for distance display 18
- 9 Trip distance recorder 18
- 10 Distance recorder 18
- 11 Program and selector lever position display for automatic transmission 69
- 12 Telltale and warning lights for electronic output control (EML), engine oil pressure, battery charge current, high beam headlights, fog lights and rear fog light 16

Indicator for ASC+T and DSC (Automatic Stability Control plus Traction/Dynamic Stability Control)

Goes out when engine is started if system is in working order.

Further details: Page 73, 75.

Left/right flashing turn indicator

Comes on rhythmically when the flashing turn indicators are in use.

Electronic engine output control

Comes on briefly when the ignition is switched and goes out again if system is in working order.

If the light remains on or comes on again during a journey, the system is defective. However, the car can still be driven, and should be taken to the nearest BMW service station.

Fasten seat belt*

Possibly together with an acoustic signal* and/or warning on Multi-Information

Display (MID)*.

Comes on briefly when the ignition is switched on, then goes out (depending on version, signal may go out only after the seat belt has been fastened).

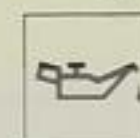
Engine oil pressure

Goes out when the engine is started. This light may come on at idle speed if the engine is

hot, but must go out again at higher engine speeds.

If the light comes on during a journey and the ENGINE OIL PRESS LOW display appears in the Multi-Information-Display (MID): stop the car and switch off the engine at once. Check engine oil level and top up if necessary. If the oil level is correct: consult BMW Service.

Battery charge

Goes out when the engine is started.

If it comes on during a journey, the batteries are no longer being charged. The alternator drive V-belt has failed or there is a fault in the alternator charge circuit.



If the V-belt is defective, increased steering and braking effort will be needed. ◀

Cars with a second alternator*: A second bulb in the telltale monitors the charge current for the second alternator. If the main alternator should fail, the car can still be driven for approx. 2 hours with the telltale light on, provided that no additional electrical consumers are switched on.

High-beam headlights

Comes on when the high-beam headlights are in use or the headlight flasher is operated.

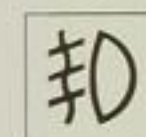
Fog lights

Comes on when fog lights are in use.

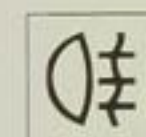
Rear fog lights

Comes on when rear fog lights are in use.

Brake and steering hydraulics

Goes out when the engine is started.

If it comes on during a journey, accompanied by the LOW BRAKE FLUID display in the Multi-Information Display (MID): brake fluid level is too low.

If it flashes during a journey and the BRAKE ASSIST INACT. display appears in the MID:

loss of pressure in the brake system or power steering circuit.



In both cases, increased steering and braking effort will be needed. ◀

Further details: Pages 98, 103.

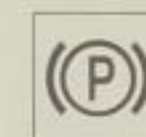
Handbrake

Goes out when the engine is started.

Comes on when the handbrake is applied.

Anti-lock brake system (ABS)

Goes out when the engine is started.

If it comes on during a journey, the ABS has ceased to operate because of a malfunction. The car can still be braked in the usual way, without any loss of efficiency.

Further details: Page 127.

Telltale for airbag

Telltale comes on for approx. 6 seconds and then goes out.

Further details: Page 44.

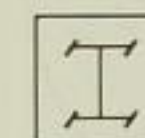
ARK (Active Rear Axle Kinematics)

Goes out when the engine is started if system is in working order.

If it comes on during a journey and the R/AXLE FAILSAFE PROG display appears in the Multi-Information Display (MID):

The ARK has cut out as a result of a fault. The car can still be driven. If the steering wheel is slightly off-centre when driving in a straight line, the car will veer slightly from the chosen line of travel.

Further details: Page 129.

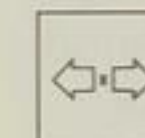
Trailer flashing turn indicators

Flashes together with the main turn indicator repeater if a turn is signalled while a trailer is being towed.

Further details: Page 123.

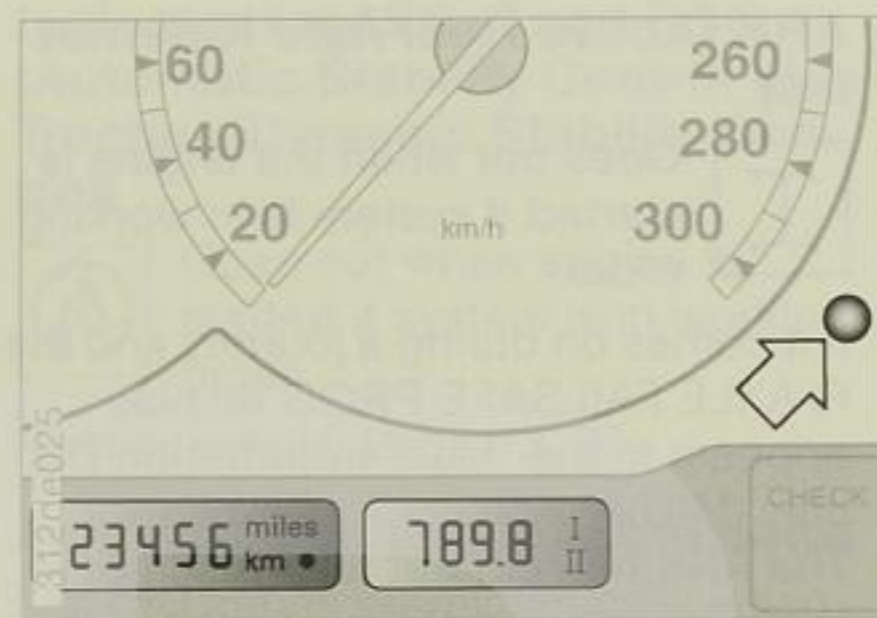

The distance recorder shows the total distance which the car has covered in miles or kilometres.

Trip distance displays I und II

You can choose between two trip distance displays (e.g. one for the whole journey and one for a specific period of driving only) and reset either of them to zero independently. Both displays show distances up to 999.9 miles/km.

Changeover (I-II-I etc.):

- ▷ Turn the reset knob (arrow) clockwise.

Resetting to zero:

- ▷ Select the desired display first, then press the reset knob.

Up to two minutes after the ignition has been switched off, the display remains visible and adjustments are possible. When the distance display is not visible, it can be recalled for a short period of time by pressing the reset knob.

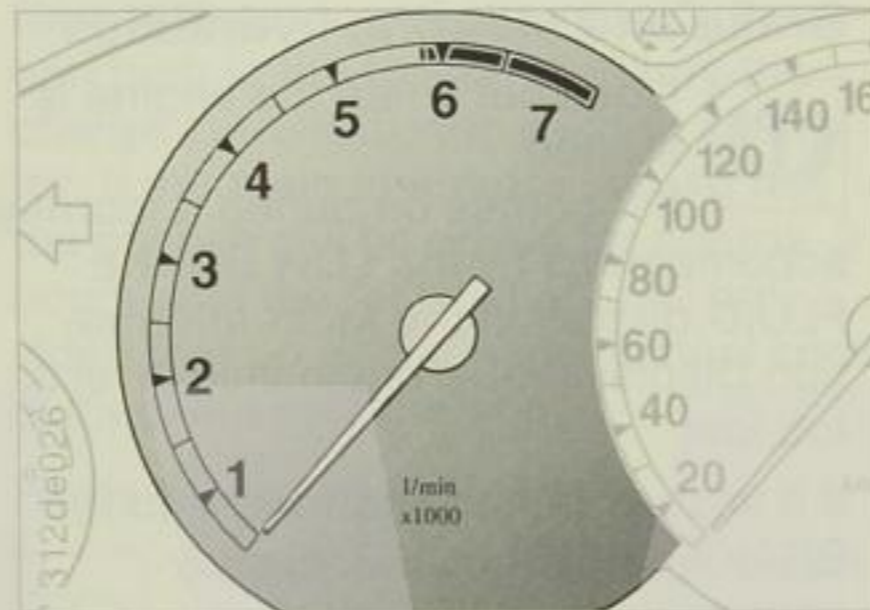

Never allow the engine to run in the red zone of the revolution counter. In this zone the fuel supply is interrupted to protect the engine. This becomes evident as the ignition cutting out intermittently.

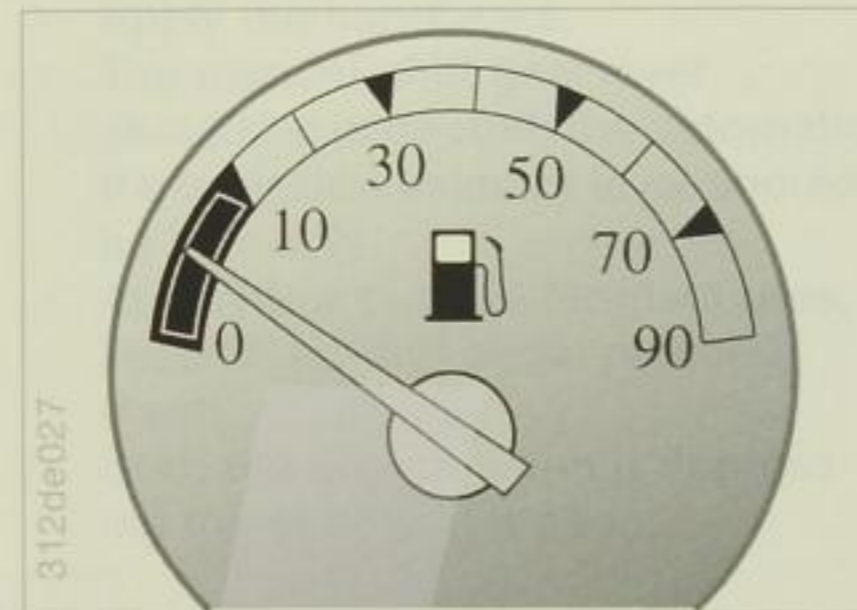

The warning light comes on briefly as an operating check when the ignition is switched on.

If the telltale light remains on for longer periods or continuously, there are only about 10 litres of fuel left in the tank.

Please add fuel in good time, since "running the tank dry" could damage the engine or the catalytic converter.

You can display the probable range on the fuel remaining in the tank on the on-board computer. See Page 57.



If the car's body is at an unusual angle, e.g. during a lengthy uphill run, the display readings may fluctuate slightly. ◀

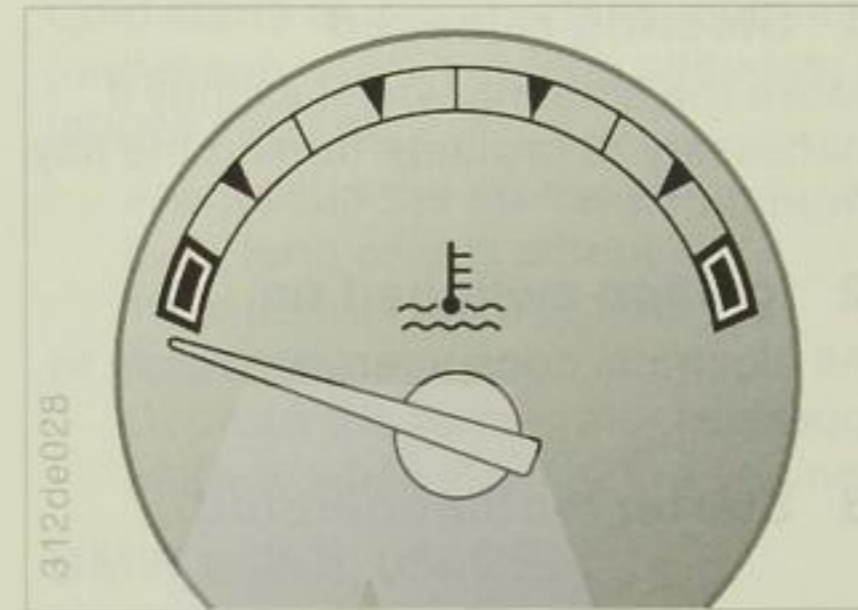

Blue:

the engine is cold. Drive at moderate engine and road speeds.

Red:

with COOLANTTEMPERATURE display in MID: the engine is too hot. Switch it off at once and allow to cool down.

Pointer between the two coloured zones:

Normal operating temperature. At high outside temperatures or when loads on the car are severe, the needle may move up as far as the beginning of the red zone.

Checking coolant level: Page 100.



0 Steering locked

The key can only be inserted and removed in this position.

After removing the key, turn the steering wheel slightly if necessary until the steering lock engages.

Automatic-transmission cars:

Do not move the selector lever away from position P until the engine is running (ignition key position).

To turn the key back to position 0 or remove it, first move the selector lever to P.

1 Steering released

Move the steering wheel slightly if necessary to facilitate turning the key from 0 to 1.

2 Ignition switched on

All electrical consumers are ready to operate.

3 Starter motor operated

Starting the engine

- ▷ Apply the handbrake.
- ▷ The manual-shift gear lever should be in neutral; the automatic transmission selector lever should be in P or N.
- ▷ At very low outside temperatures, keep the clutch pedal pressed down.
- ▷ Start the engine without depressing the accelerator pedal.

▶ Allow the starter motor to run for a reasonable time, but not for more than about 20 seconds. As soon as the engine fires, release the ignition key.

Do not allow the engine to warm up at a standstill, but drive off as soon as possible, using moderate engine speeds. ◀

If the engine does not start first time, for instance if it is very cold or very hot:

- ▷ Depress the accelerator pedal halfway while starting the engine.

Cold starts at very low temperatures (under app. -15°C) at high altitudes (above 1000 m):

- ▷ Always run the starter motor for a fairly long period (about 10 seconds) the first time it is operated.
- ▷ Depress the accelerator pedal halfway while starting the engine.

BMW 840Ci, 850CSi

If the car is to be used for lengthy periods at high altitudes and at extremely low temperatures, have the engine oil changed to 5W-X grade (see Page 97). Please contact BMW Service.

⚠ Never run the engine in an enclosed space. The exhaust gas contains carbon monoxide, which is colourless and odourless, but highly toxic. Inhaling exhaust gas constitutes a severe health risk and can lead to loss of consciousness with fatal consequences.

Never leave the car unattended with the engine running, as it then represents a serious potential hazard. ◀

Stopping the engine

Turn the ignition key back to 1 or 0.

⚠ Never take the ignition key out when the car is still in motion or the steering lock will engage. Whenever the driver leaves the car, he or she should remove the ignition key and lock the steering.

Manual-gearbox cars: when parking the car on a slope, apply the handbrake, as merely selecting 1st gear or reverse may not be sufficient to prevent the car from rolling away. Automatic-transmission cars: select position P. ◀

Please comply with the following instructions, which are intended to ensure that your car achieves its optimum operating life and economy.

Engine and final drive BMW 840Ci, 850Ci

Up to a distance reading of 2000 km (app. 1300 miles):

Drive the car at varying engine and road speeds, but do not exceed an engine speed of 4500/min or a road speed of 170 km/h (106 mile/h).

Avoid full throttle and do not use the automatic transmission kick-down.

After 2000 km (app. 1250 miles) have been covered, engine and road speeds can be gradually increased.

If the engine or final drive is exchanged later in the car's life, repeat the running-in procedure.

BMW 850CSi

Up to a distance reading of 2000 km (app. 1300 miles):

Do not exceed a max. engine speed of 5500/min.

Max. road speed 160 km/h (100 mile/h).

Do not use the full throttle position of the accelerator.

Up to a speedometer reading of 5000 km (app. 3100 miles):

Max. continuous road speed 200 km/h (124 mile/h).

Use top speeds for short periods only.

If the engine or final drive is exchanged later in the car's life, repeat the running-in procedure.

Tyres

New tyres do not achieve their full road grip immediately, for production reasons. You should therefore drive in a restrained manner for the first 300 km (app. 200 miles).

Brakes

Brake pads and discs do not achieve a favourable wear and contact pattern until the car has covered about 500 km (300 miles).

 The brake lights do not come on when the handbrake is applied. ◀

Refuelling

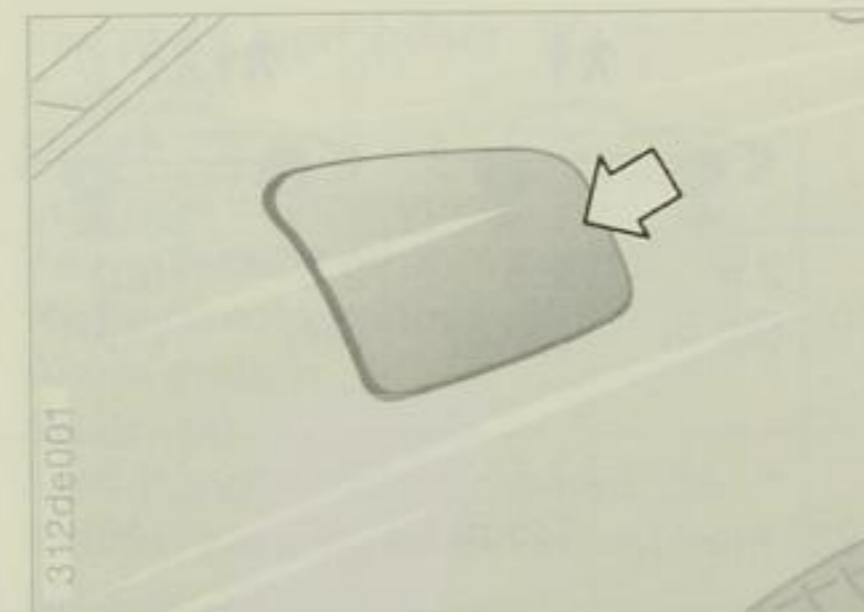

To open the fuel filler flap, press the front end in so that the flap can be lifted.

 When refuelling, insert the pump nozzle fully into the filler pipe. If the filler nozzle is raised during refuelling

- ▷ the supply of fuel will be cut off prematurely
- ▷ and on filler nozzles with fuel vapour recovery, the recirculating function will be less effective. ◀

To release the fuel filler flap if the central locking system fails, see Page 114.

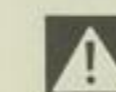
 Comply with the relevant safety regulations when handling fuel. ◀

Fuel grade

Spark-ignition engine with catalytic converter

BMW 840Ci, 850Ci

The engine should be run exclusively on unleaded fuel. Since the engines have a knock control function, they can run on different grades of fuel.

Minimum fuel grade:
regular grade, unleaded (91 (RON)).

The rated performance and fuel consumption values are achieved with:
super (premium) grade unleaded fuel (octane number 95, Research Method). This fuel is also referred to as DIN EN 228 or Euro-Super.

For higher performance and lower fuel consumption, it is also possible to use Super Plus/premium plus fuel (octane number 98, Research Method).

BMW 850CSi

Minimum fuel grade: Super (premium), unleaded (95 octane, Research Method).

The rated performance and fuel consumption values are achieved with:
Super Plus unleaded (98 octane, Research Method).

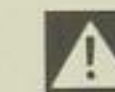
 Never use fuel containing lead if the car is equipped with a catalytic converter, or else the lambda probe and the converter will be damaged beyond repair. ◀

Spark-ignition engines without catalytic converter

(Note: a catalytic converter can be retrofitted.)

The engine is designed to run on both unleaded and leaded fuel. Since the engines have a knock control system, they can run on different grades of fuel.

Minimum fuel grade:
Regular-grade unleaded or leaded fuel (octane number 91, Research Method).

The rated performance and fuel consumption values are achieved with:
Premium-grade unleaded fuel (octane number 95, Research Method). This fuel is also referred to as DIN EN 228 or Euro-Super.

For higher performance and lower fuel consumption, it is also possible to use Super Plus, 98 octane (RON) unleaded or Super (premium), 98 octane (RON) containing lead.
Super (premium) fuel is also referred to as DIN 51 600.

Check regularly for your personal safety:

 Incorrect tyre pressures can render the car unstable and lead to tyre damage or even cause an accident. ◀



Tyre pressures in bar – gauge pressure – (psi) with tyres cold (cold = ambient temperature).

These tyre pressures apply to makes of tyre approved by BMW and known to the BMW Service Organization.

If other makes of tyre are fitted to the car, higher tyre pressures may be needed.

The information relevant to your car is shown on a label attached to the driver's door post.

When towing a trailer, always use the values for the higher load.

BMW Model	Tyre size				
		2.5 (35.5)	2.5 (35.5)	2.6 (37)	3.0 (43)
840Ci 850Ci	235/50 R 16 95 W 225/55 R 16 95 Q,T, H M+S 235/50 R 16 95 Q,T, H M+S	2.5 (35.5)	2.5 (35.5)	2.6 (37)	3.0 (43)
	265/40 R 17 96 W* 265/40 ZR 17**	–	2.5 (35.5)	–	2.8 (40)
	235/45 R 17 93 W 235/45 ZR 17 235/45 R 17 93 Q,T, H M+S	2.7 (38.5)	2.7 (38.5)	2.8 (40)	3.2 (45.5)
850CSi	235/45 ZR 17	2.9 (41.5)	2.9 (41.5)	3.2 (45.5)	3.2 (45.5)
	265/40 ZR 17**	–	2.9 (41.5)	–	3.5 (50)
	235/45 R 17 93 Q,T, H M+S	2.5 (35.5)	2.7 (38.5)	2.7 (38.5)	3.0 (42.5)
	245/40 ZR 18	2.9 (41.5)	–	3.2 (45.5)	–
	285/35 ZR 18***	–	2.9 (41.5)	–	3.5 (50)

* Only permissible as mixed set with 235/45 R 17 93 W at front.

** Only permissible as mixed set with 235/45 ZR 17 at front.

*** Only permissible as mixed set with 245/40 ZR 18 at front.

Electronic immobiliser 26
Keys 26
Doors 27
Luggage compartment 29
Key with radio remote control 30
Radio remote control 30
Alarm system 34
Seats 36
Steering column adjustment 38
Electric steering wheel adjustment 39
Mirrors 40
Position memory for seats, mirrors and steering wheel 42
Seat belts 42
Airbags 44
Main light switch 45
Fog light switch 46
Turn indicators/low beams 46
Hazard warning flashers 47
Interior light/footwell lights 47
Headlight beam throw adjustment 48
Wipe/wash system 48
Electric windows 50
Sunroof 51
Multi-Information Display (MID) 52
Service Interval indicator 53
Digital clock 54
On-board computer 56
Check Control 64
Handbrake 67
EML 68
Manual gearbox 68

Automatic transmission with STEPTRONIC 69
Cruise control 72
EDC 73
ASC+T 73
DSC 74
Automatic air conditioning 76
Heated rear window 81
Independent heating 82
Independent ventilation 82
Roller sunblind 83
Glove boxes 83
Ashtray 84
Rear seat back 85
Ski bag 85

Important facts in brief**Controls****Operating hints****Care and maintenance****Technical data****Index**

The electronic immobiliser reduces the likelihood of your BMW being stolen. It prevents the engine from being started except with the car's correct keys.

In addition to the mechanical matching of lock and keys, this is achieved by a special electronic component integrated into the key.

The vehicle's electronics exchange constantly updated signals, which are individualised for every vehicle, between the ignition switch and the electronic components in the key. The ignition, fuel supply and starter motor cannot operate until the key has been identified as valid.



The electronic components in the key could become damaged if treated violently. This could prevent you from starting the engine. ◀

Obtaining a new key:

Spare keys are only available from BMW Service, which is obliged to check that you are entitled to order them.

BMW Service can also invalidate individual keys (e.g. if they are lost), or reinstate them. The engine cannot be started with an invalidated key.

Keys

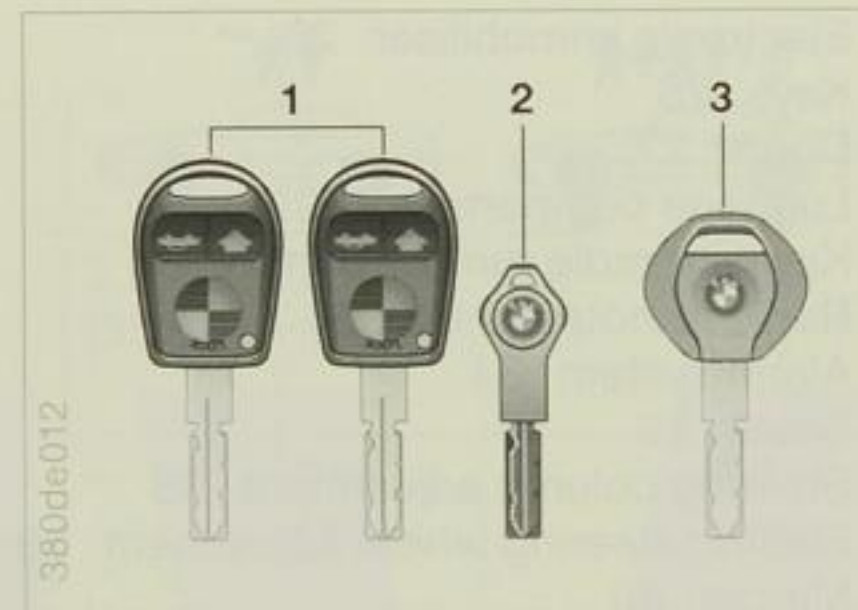

- 1 Master key with transmitter for remote control
- 2 Spare key to keep in a safe place, e.g. in a purse or wallet. This is a master key, but is not intended for regular use
- 3 Key for doors and ignition. This key does not operate the luggage compartment or glove box lock. It is useful at a hotel, for example.

The passenger's door has no outside lock, as an additional precaution against theft. The safety button on the passenger's door does not operate the central locking system.

Doors

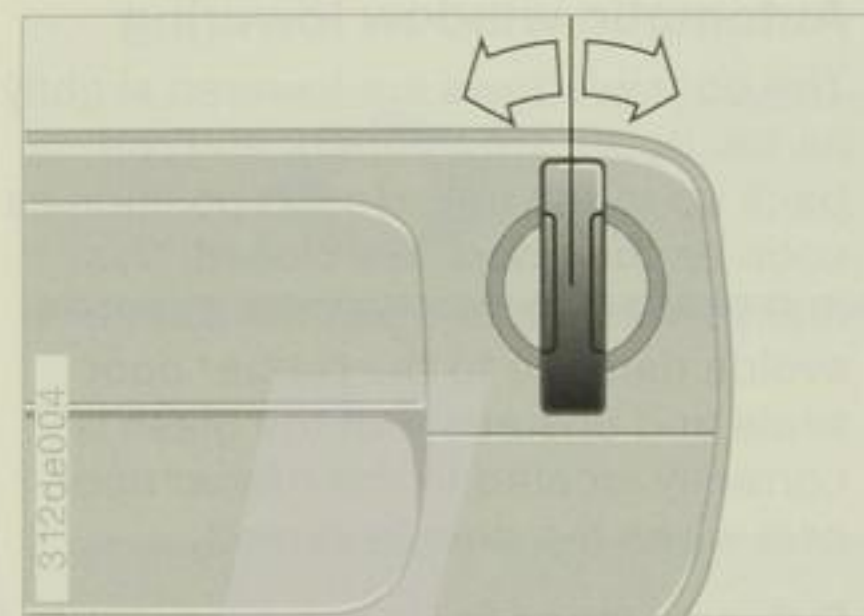

Central locking from the outside

When the doors, luggage compartment and fuel filler flap are closed they can be locked and unlocked with a key at the door lock.

At the same time, the deadlock is operated. It prevents the doors from being unlocked either at the safety lock buttons or door handles.

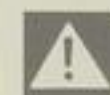

Do not lock the car either with the key or the remote control if anyone is to remain in it, since it cannot then be unlocked from the inside. ◀

If your car is equipped with an alarm system, it is also activated or de-activated with the key at the door lock.

For further details of the alarm system, see Page 34.

Convenience circuit

The electric windows and the sliding/tilt roof can also be operated via the door lock.

To open: when the door is closed, turn the key in the door lock to the release position and hold it there.

To fasten: when the door is closed, turn the key to the locking position and hold it there.

Release the key to halt the movement.

Emergency operation

(in the event of an electrical malfunction)

When the key is turned to the limit of movement in the door lock, the driver's door can be unlocked or locked.

Operating the central locking system from the inside

If the safety button on a door is operated, the doors and luggage compartment only are locked or unlocked, but the deadlocks are not operated.



If the car is locked from the inside at one of the safety buttons, the fuel filler flap remains unlocked, so that the car can be refuelled. ◀

Unlocking from the inside is also possible if one of the door handles is pulled.

To avoid being accidentally locked out of the car

- ▷ the car cannot be locked with the lock button if the driver's door is open.
- ▷ the lock button on the passenger's door only operates the central locking system if both doors are closed.



Note that children could lock the doors from the inside if they are alone in the car. Always take the key with you so that the car can be unlocked from the outside. ◀

In the event of an accident, the central locking system is released automatically and the interior lighting is switched on. The hazard warning flashers also operate (depending on national-market version).

Opening doors from the inside

- ▷ Either unlock all doors at the central locking pushbutton and then operate the door handle above the armrest, or
- ▷ Pull the door handle out twice at any door: the first time to unlock the door, the second time to open it.

Opening doors from the outside

Raise the flap handle.

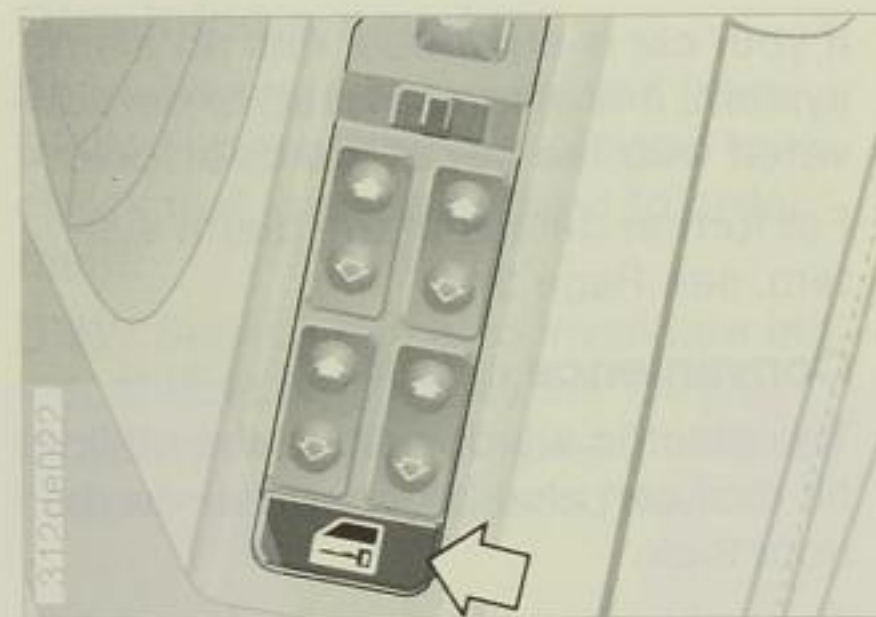

Central locking system pushbutton

This pushbutton also operates the central locking system when the driver's door is closed.

Automatic window lowering

The door windows are lowered slightly as the doors are opened, and run back up to the fully closed position as soon as the doors are closed. This makes it easier to open the doors, avoids damage to the rubber door seals and ensures that the glass is correctly located in the rubber door seal when the door is closed.

Driver's door lock heating

Raise the driver's door handle: the heating is switched on. The heating time is regulated automatically to reduce electric power consumption.

Luggage compartment

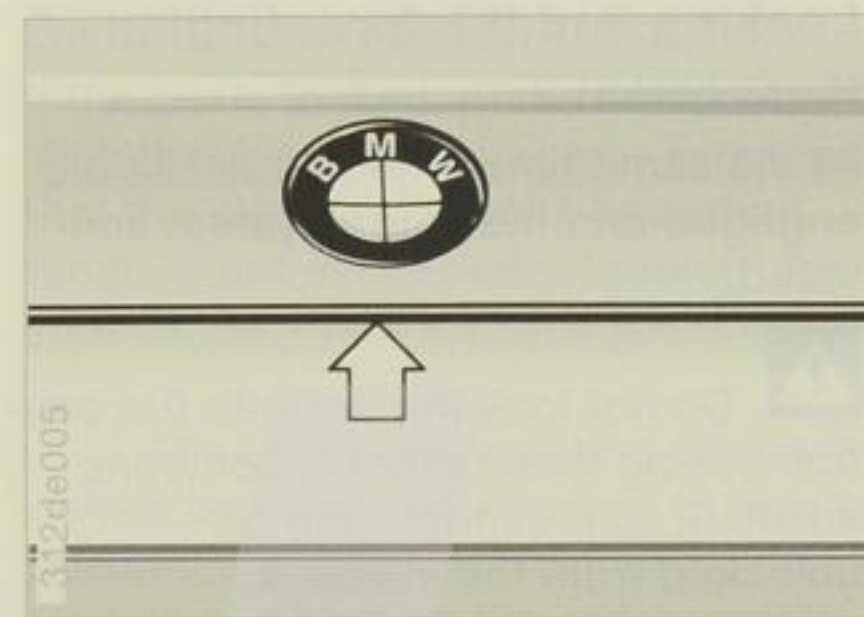

To open:

- ▷ Release by the way of the central locking system at a door lock or the lock on the glove box.
- ▷ Press the button under the BMW badge.

Manual operation in the event of a fault: See Page 115.

To close:

- ▷ Shut the luggage compartment lid.
- ▷ Lock by the way of the central locking system at a door lock or the lock on the glove box.

Access to the luggage compartment is prevented when the glove box is locked and the door and ignition key 3 has to be handed over – this is important, for example, at a hotel.

Luggage compartment light

This light comes on when the lid is opened.

To attach luggage compartment nets* or prevent items of luggage from moving, lashing eyes are provided on the floor and the rear panel of the luggage compartment.



The luggage compartment lid should always be kept closed while the car is moving, to prevent exhaust fumes from entering the car. If, in exceptional circumstances, it is necessary to travel with the luggage compartment lid opened, close all windows and the sliding/tilt roof and select a high airflow setting at the airflow volume selector of the automatic air conditioning system. ◀



Releasing

Press button 1.

At the same time the deadlocks are released, the alarm system de-activated and the interior light switched on.

Convenient opening

The electric windows and sliding/tilt roof can also be opened via the remote control:
Hold button 1 depressed. Releasing the button interrupts the opening movement immediately.

Locking and thiefproofing

Press button 2.

At the same time, the deadlocks are engaged and the alarm system activated.

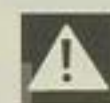

Do not lock the car with the central locking when there is someone inside it, as it cannot then be unlocked from the inside. ◀

Radio remote control

Switching the interior light on

If the car is locked, press button 4. With this function, you can – provided that the remote control's operating range is not exceeded – "search" for your car, for instance on a parking lot.



The LED (light-emitting diode) (3) comes on briefly whenever a button is pressed. Certain symbols on the radio remote control may differ from those illustrated here. ◀

Switching off tilt alarm sensor

After locking, press button 2 again briefly (see Page 34).

Master keys

The keys with remote-control transmitter are master keys.

Apart from the "Switching on interior light" function, the conventional keys perform the same functions as the remote control when inserted and turned in the lock.



On some national-market versions, the alarm system can only be operated from the remote control. If such cars are unlocked manually with the master key, the alarm will be triggered off.

To switch off the alarm: press button 1 (unlock) or start the engine. ◀

For further details of the alarm system, see Page 34.

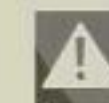

Note that children could lock the doors from the inside if they are alone in the car. Always take the key with you so that the car can be unlocked from the outside. ◀

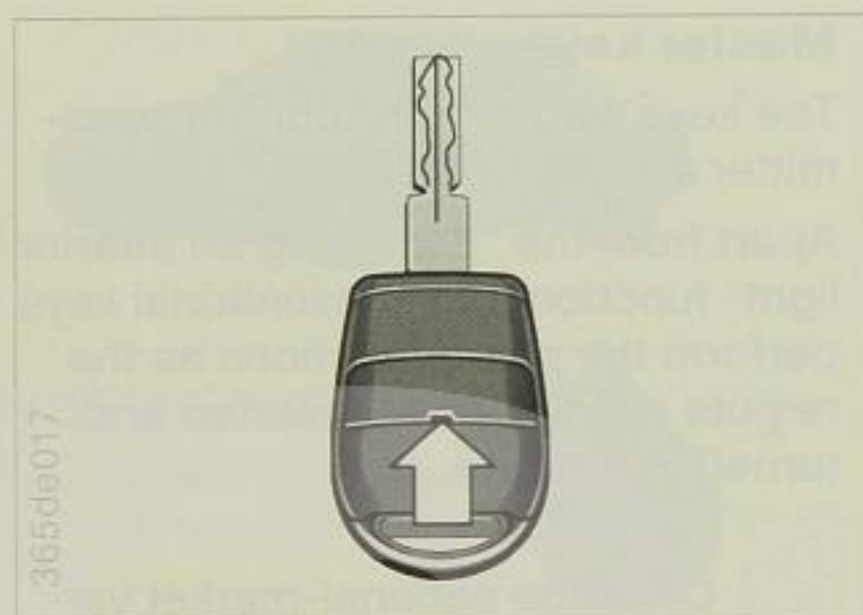

Batteries

Renew the battery if the LED no longer lights up when a button is pressed, and the doors cannot be locked with the remote control:

- 1 Open the car with the remote control.
- 2 Lever off the cover by inserting a screwdriver blade at the cutout (arrow).

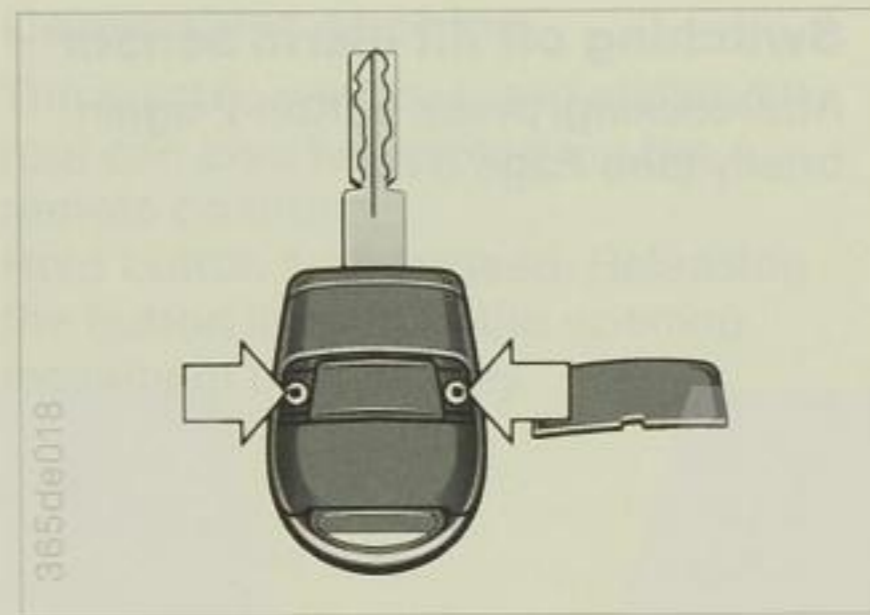

- 3 Remove the screws (arrows) and take off the cover.

The battery type and correct installed position are marked on the base of the battery compartment.

 Use only a battery of the stated type (CR 2016). Make sure that the batteries are inserted correctly. ◀

 Return discarded batteries to a collecting point for used batteries or to your BMW Service point. ◀



Initialising the remote control

This may be necessary for example after obtaining a new key. The new transmitter must be initialised before it can be used.

- 1 The driver's door must have been opened with the remote control.

 If the car was not opened with the remote control, an interlock is triggered off and remains in effect for 15 minutes with the ignition switched on. ◀

- 2 Enter the car and close the driver's door.
- 3 Turn the ignition key briefly (for not more than 5 seconds) to position 1, then back to position 0.
- 4 Press button 1 on the remote control (see illustration) and hold it down. Press button 2 briefly three times in succession within 10 seconds, while button 1 is held down.
- 5 Release button 1. The LED will flash slowly for max. 10 seconds.
- 6 The central locking system indicates that initialisation has been performed successfully by closing and releasing the locks in rapid succession.

If the LED does not flash and the central locking system does not operate, the initialising procedure must be repeated.

If you use additional remote-control transmitters for the same car, each of them (up to four) must be initialised within a further 30 seconds (repeat steps 4 to 6), otherwise they will be de-activated.

In the event of faults, contact BMW Service, which can also supply replacement transmitters.



Make sure that the radio remote control transmitter is not misused, for example by only handing hotel staff door/ignition key 3 or the spare key. ◀

Interference

The radio remote control may be susceptible to local interference from other systems or equipment operating on the same frequency.

The alarm system reacts if:

- ▷ a door, the engine compartment or the luggage compartment is opened.
- ▷ the car's attitude changes, for instance if it is jacked up to remove a wheel or if it is towed away.
- ▷ the power supply from the battery is interrupted.

It has three ways of indicating that the car has been tampered with:

- ▷ by sounding an alarm for 30 seconds
- ▷ by switching on the hazard warning flashers for five minutes*.
- ▷ by switching the low-beam headlights on and off in the same rhythm as the hazard warning flashers*.

On some national-market versions, the alarm system can only be operated from the remote control.

If such cars are unlocked manually with the master key, the alarm will be triggered off.

Pressing button 1 (unlocking) or starting the engine will switch the alarm off.

If you have any queries, your BMW Service station will be glad to advise you.

Activating and de-activating

Activating and de-activating take place when the door key is turned or the remote control operated.

Activation is confirmed by the hazard warning flashers lighting up once only.



Alarm system telltale

- ▷ If the LED on the centre console flashes repeatedly: the system is activated.
- ▷ If the LED flashes during the activating routine: not all doors, engine or luggage compartment or glove box are correctly closed, or a side window is open by more than a small amount (app. 10mm). But even if the item concerned is not closed correctly, the remaining items are protected and the LED will flash continuously after 10 seconds.
- ▷ If the LED goes out when the system is de-activated: no attempt was made to enter the car during your absence.

- ▷ If the LED flashes for 10 seconds when the system is de-activated: an attempt was made to tamper with the car.

If an alarm is triggered off, the LED flashes for 5 minutes and then reverts to the regular operating mode.

When the system is activated, there is no access to the luggage compartment. If the LED flashes fairly rapidly (10-second intervals), this indicates that the luggage compartment lid was closed but not locked (key turned to right and removed).

To prevent an unwanted alarm signal being set off by the tilt detector, for example when the car is carried on a train or parked in elevating garages, this part of the system can be put out of action temporarily:

Immediately after activating the alarm system, repeat the activating procedure (in other words, turn the key to the locking position or press the remote control button a second time).

The LED lights up briefly and then flashes continuously. The tilt alarm sensor is then out of action until the entire system has been de-activated.

Emergency de-activating*

If normal de-activation is not possible, adopt the following procedure:

- 1 Open the door with a key. After the door has been opened, the alarm will sound for 30 seconds.
- 2 Turn the ignition key to position 1 so that the central locking system can release the remaining doors.

The system is now de-activated, but should be examined by BMW Service.

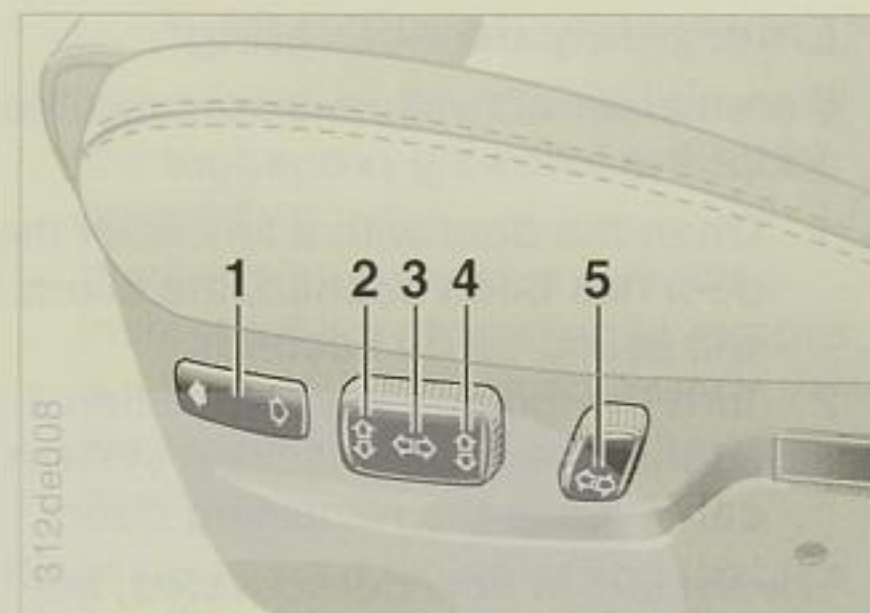

Electric seat adjustment

- 1 Rocker switch for adjusting thigh support (only on BMW Sport seat)

To adjust, move switch in direction of arrow:

- 2 Seat angle adjustment*
- 3 Forward/back movement
- 4 Seat height adjustment
- 5 Seat back angle adjustment

Head restraints

These are automatically adjusted in height whenever the seat height or backrest is repositioned.

Their angle can be adjusted manually.



To relieve the load on the discs of the spine, sit well back in the seat with your back resting firmly against the seat back.

The ideal position is when the head is a straight-line extension of the spinal column.

On a long journey, the seat back can be inclined slightly more, to reduce muscular strain. You should still be able to reach the highest point on the steering wheel with the arms slightly bent. ◀



Do not reposition the driver's seat while the car is in motion. A sudden seat movement could cause you to lose control of the car and result in an accident.

During a journey, neither the driver's nor the front passenger's seat back should be reclined to an excessive angle. Otherwise there is a risk in the event of an accident that the seat occupant could "submarine" under the seat belt, which would then fail to exert its full protective action (see also safety instructions concerning "Seat belts").

Do not push the front seats rearwards if the car is standing on a slope (e.g. a garage entrance ramp or similar), or the automatic seat belt height adjusters could become disconnected. ◀

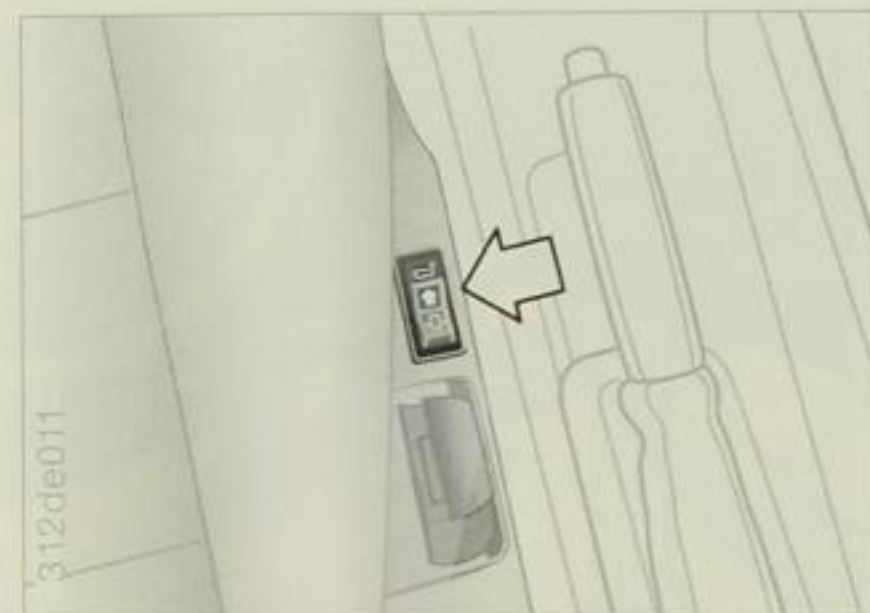

Lumbar support*

The seat back contour can be altered to provide more support to the curved (lumbar) section of the spine.

The upper edge of the pelvis and the spinal column are supported, to encourage an upright but relaxed seated position.

Press the switch forwards to increase the curvature of the support.

Press the switch backwards to reduce the curvature of the support.

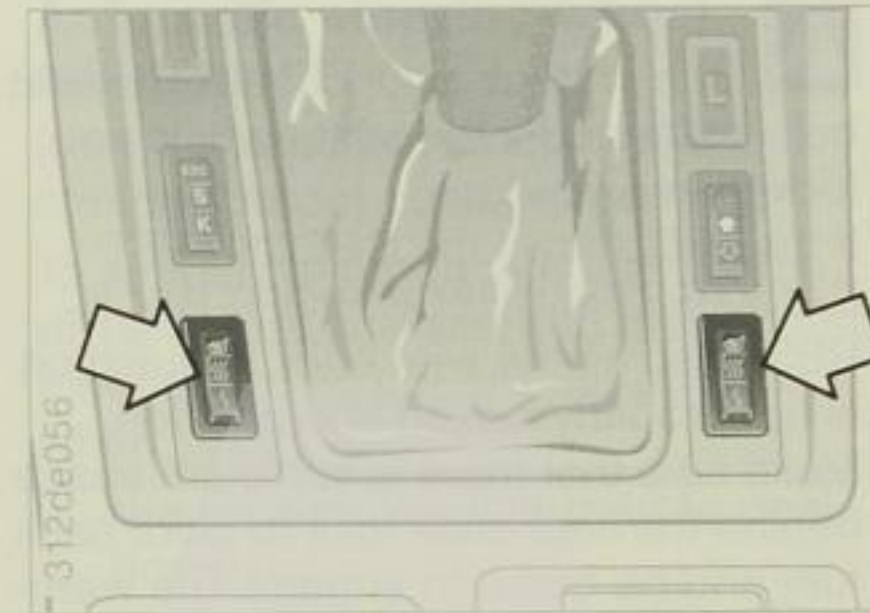

Seat heating

The seat base cushion and the seat back can be heated. The heating only operates when the engine is running.

Press the switches with the heating symbols:

☺ Rapid heating while the symbol is illuminated. Automatic change-over to regular heating.

☺ Regular heating. Cuts out automatically when the switch is no longer illuminated.

To switch over while heating: press the non-illuminated section of the switch.

To switch off prematurely: press the illuminated section of the switch.

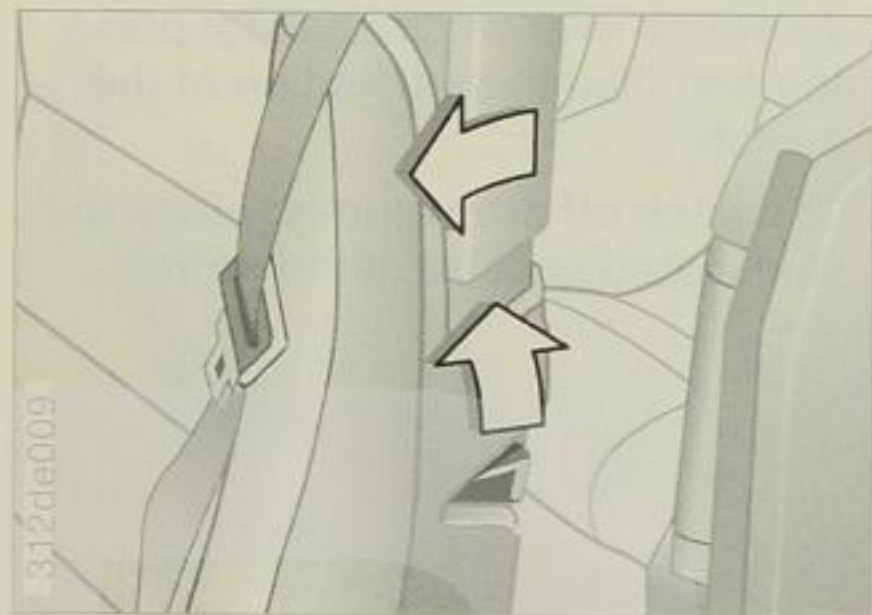

Seat back release

Press the lever up and pivot the seat back forwards.

- !** The protective function of the seat belt is affected if the seat back is not locked into position. If the MID shows the CHECK LEFT BACKREST or CHECK RIGHT BACKREST display, the seat back in question is not properly locked into position. Make sure that there is sufficient space behind the seat back for it to pivot back fully and be heard to engage. The warning display goes out as soon as the seat lock has engaged. If the warning display does not go out although the seat back has engaged correctly, consult BMW Service. The car must not be driven with a seat occupied but the seat back not locked in position. ◀

Steering wheel

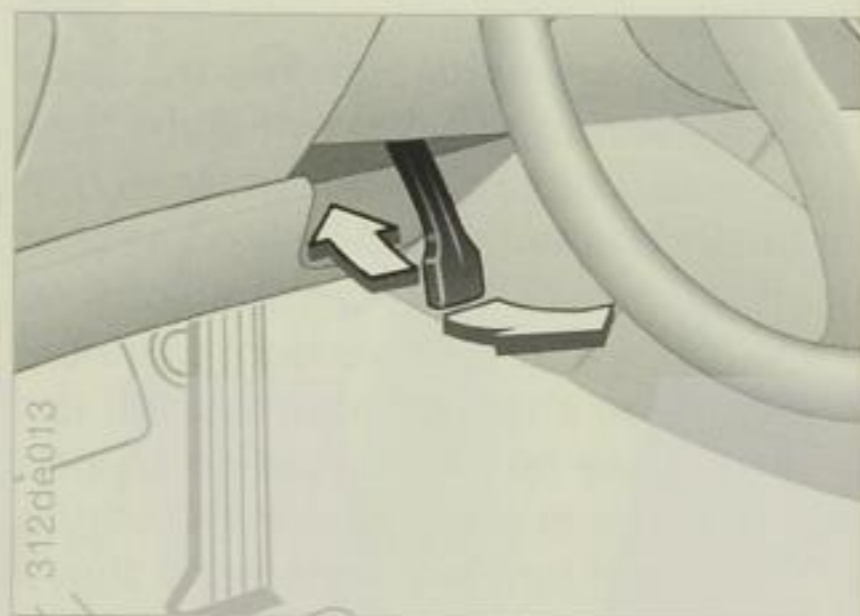

- ▷ To adjust, fold out the clamp lever.
- ▷ Push or pull the steering wheel until the desired reach position is obtained.
- ▷ Fold the lever back in to clamp the steering column in the new position.

! Adjusting the position of the steering column while the car is being driven represents an accident risk. ◀

Electric steering wheel adjustment*

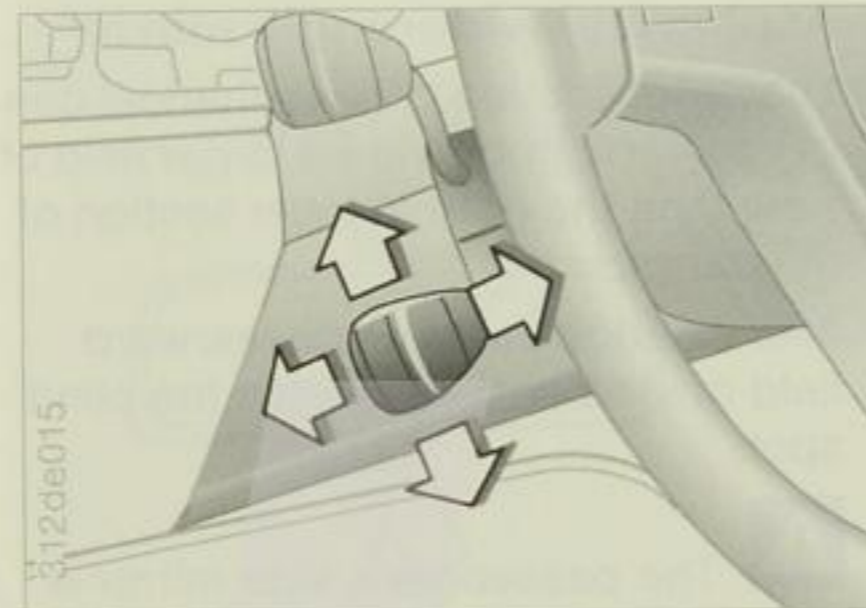

The steering wheel can be adjusted in four directions, which are simulated by the adjusting lever movements.

- !** Adjusting the position of the steering column while the car is being driven represents an accident risk. ◀
- For memorising the steering wheel position, see "Seat, mirror and steering wheel position memory", Page 42.

Automatic steering wheel adjustment*

(only on cars with seat, mirror and steering wheel position memory)

To simplify entering and leaving the driver's seat, the steering moves automatically to its uppermost position when:

- ▷ the ignition key is turned to position 0
- ▷ the ignition key is in position 1 and the driver's door is opened
- ▷ the ignition key is in position 2, the handbrake is applied and the driver's door is opened.

The steering wheel returns to the driving (memorised) position when:

- ▷ the ignition key is in position 2 and the handbrake is released with the driver's door open
- ▷ the ignition key is in position 2, the handbrake is applied and the driver's door is closed.

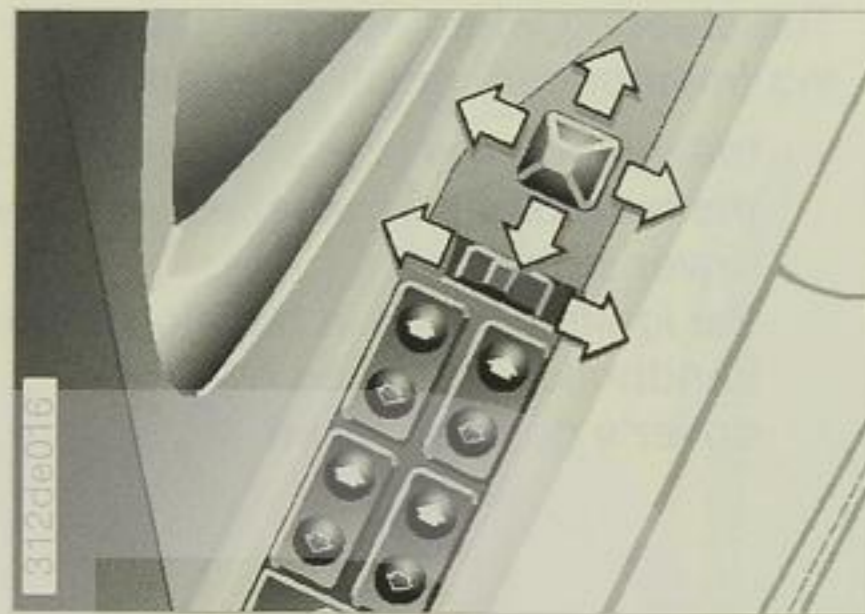

Electric outside mirrors

These can be adjusted in four directions with the mirror control switch.

Changeover switch for the other mirror:

Move switch to left – for driver's mirror.

Move switch to right – for passenger's mirror.

The mirrors can also be adjusted manually by pressing the edge of the glass.

For memorising mirror positions, see "Seat, mirror and steering wheel position memory", Page 42.

Tilting down mirror on passenger's side

(automatic kerb position)
(only with seat, mirror and steering wheel position memory)

- 1 Move the mirror changeover switch to the driver's side position.
- 2 When reverse gear (or automatic transmission selector lever position R) is selected, the mirror on the passenger's side will tilt down slightly to display the ground along the side of the car (for instance the edge of the kerb).

This automatic function can be switched off if not required: move the mirror changeover switch to the passenger's side position.

Aspherical wide-angle mirror*

The outer section is of aspherical convex pattern, to provide a larger field of view than the normal inner section of the mirror.

This extends the driver's rearward field of view and eliminates the blind spot.

 The passenger's side mirror is convex (on the BMW 850CSi, both outside mirrors are convex), so that reflected objects are closer than they seem. It can be difficult to estimate the precise distance at which another vehicle is following your car. The same applies to the convex section of partly-convex aspherical wide-angle mirrors. ◀

Electric mirror heating

Both outside mirrors are automatically heated (controlled heat output) in ignition key position 2.

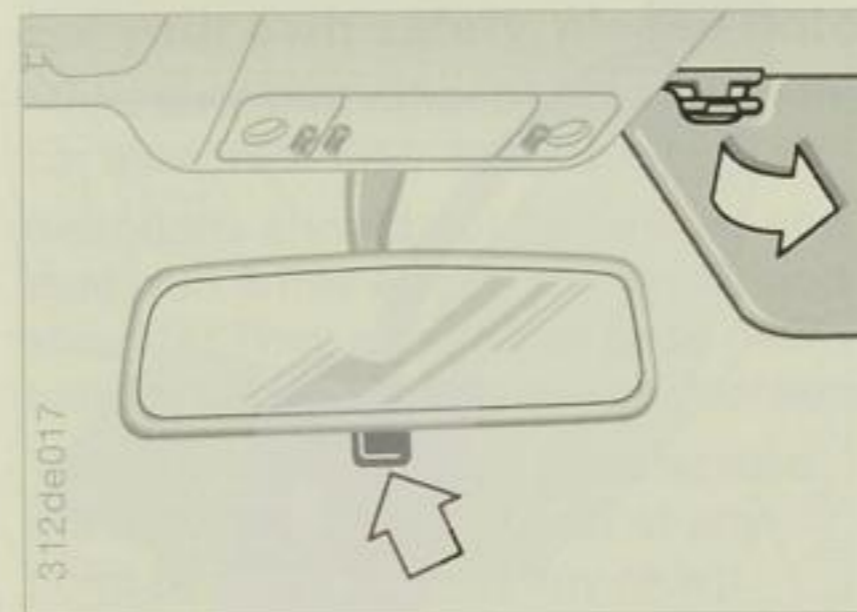

Inside mirror

To reduce glare from the headlights of following vehicles after dark, move the small lever to tilt the mirror.

Make-up mirrors

Fold the sun visor down and slide the mirror cover sideways.

The mirrors are illuminated when the car's outside lights are switched on.

Sun visors

The sun visors can also be pivoted to the side, against the door windows.

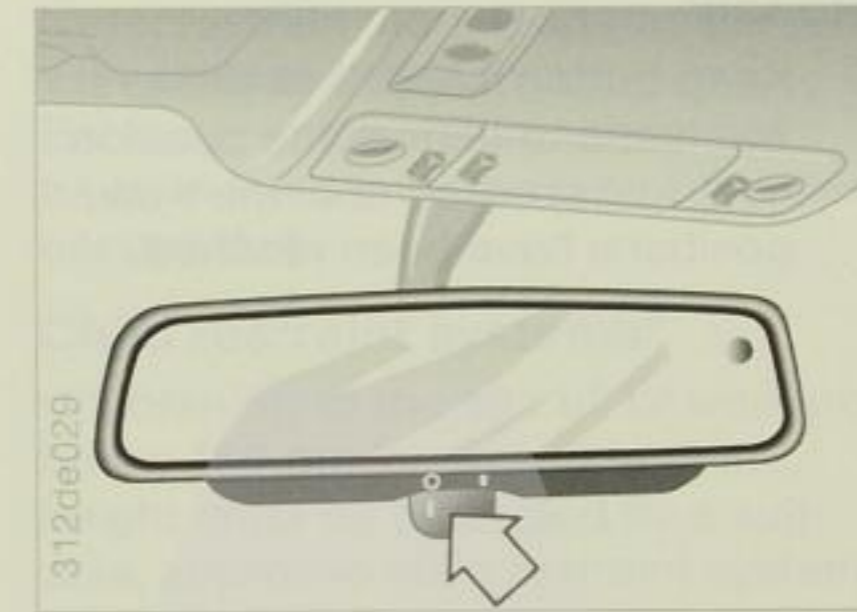

Automatic anti-glare inside mirror

Knob in position 0: automatic anti-glare function out of action.

Knob in position 1: the mirror dims automatically and continuously when light strikes it (from the surrounding area as well as other vehicle's headlights).

When reverse gear is selected, the mirror reverts from either position to the clear-glass (non-dimmed) setting.

 The mirror will not operate reliably unless the photo-electric cells are kept clean and are not obstructed. ◀

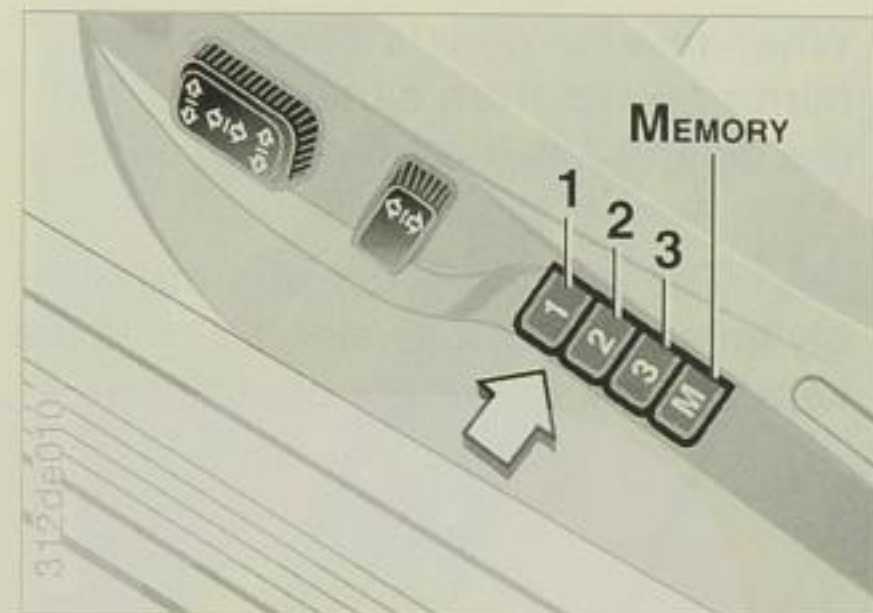

Three different seat, outside mirror and (only with electric steering wheel adjustment) steering wheel positions can be memorised.

Memorising:

- ▷ The ignition key must be in position 1 or 2.
- ▷ Select the desired seat, outside mirror or steering wheel position.
- ▷ Press the MEMORY button: the telltale light in the button comes on.
- ▷ Press button 1, 2 or 3 as required in the direction of the arrow: the telltale light goes out.

Recall:

- ▷ Keep button 1, 2 or 3 (whichever was used to restore the position settings) pressed until the new positions have been reached.

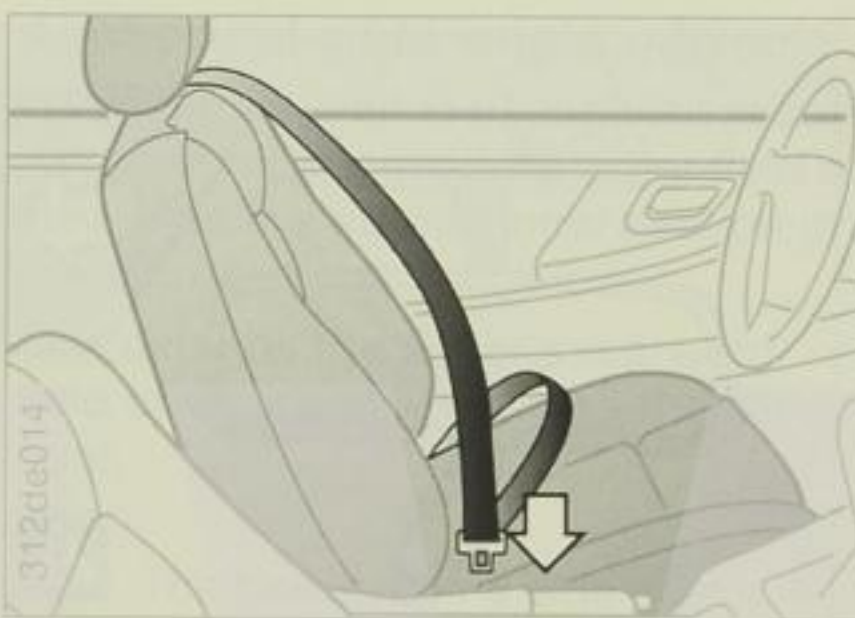

Fasten seat belts before starting every journey.

You do not have to adjust the front seat belt manually. The seat-integrated belt system resets itself automatically to accommodate wearers of different sizes.

Fastening the belt:

The seat belt buckle must be heard to engage.

Releasing the belt:

Press the red release button on the belt catch and guide the belt back if necessary to reinforce the action of the automatic reel.

For your own safety, please note:

Make sure that other occupants of the car also wear their seat belts.

Seat belts should not be twisted and must run firmly across the pelvis and shoulder. They should not pass over hard or fragile objects in your pockets.

The seat belt must not pass across the neck, become trapped at any point or chafe against any sharp edges.

The belt should be as close to the body as possible; therefore avoid wearing thick and heavy clothing.

Take up slack regularly by pulling up the belt at the shoulder.



For the following reasons, it is essential for the belt not to be worn slack:

In the event of a head-on collision, the lap belt could otherwise slide over the hips and injure the lower part of the body. Furthermore, excessive belt slack delays the restraining action. Pregnant women are also advised to wear the seat belt at all times, making sure that the lap belt is low down over the hips and does not press against the abdomen.

Never restrain more than one person with each seat belt. Babies or small children must not travel in the car on the lap of another occupant. ◀

Child restraint systems*

Children up to the age of 12 who are below 150 cm (approx. 5 feet) in height must be protected by a suitable, approved child restraint system.

Babies up to 18 months can travel on the rear seat in a suitable cot or shell facing rearwards and retained by the standard seat belts.

BMW Service can supply suitable child restraint systems for the various age groups.



Child restraint systems are not to be attached to the front passenger seat. ◀

To permit a child's restraint system to be retained securely with the seat belt, your BMW is equipped with a lockable automatic seat belt reel.

Pull the belt out fully. Allow it to retract until the child restraint system is held securely.

After releasing the belt and allowing it to retract fully, the automatic reel will again operate normally.

In no circumstances are seat-belt or child restraint systems to be modified.

The seat belt reel will lock:

- ▷ if pulled out rapidly,
- ▷ during sudden braking or accelerating,
- ▷ when the car is cornered sharply,
- ▷ if the car is tilted at a considerable angle.



Drivers should ensure that their passengers also comply with the relevant requirements and instructions concerning seat belts. ◀

For care of belts, see Page 141.

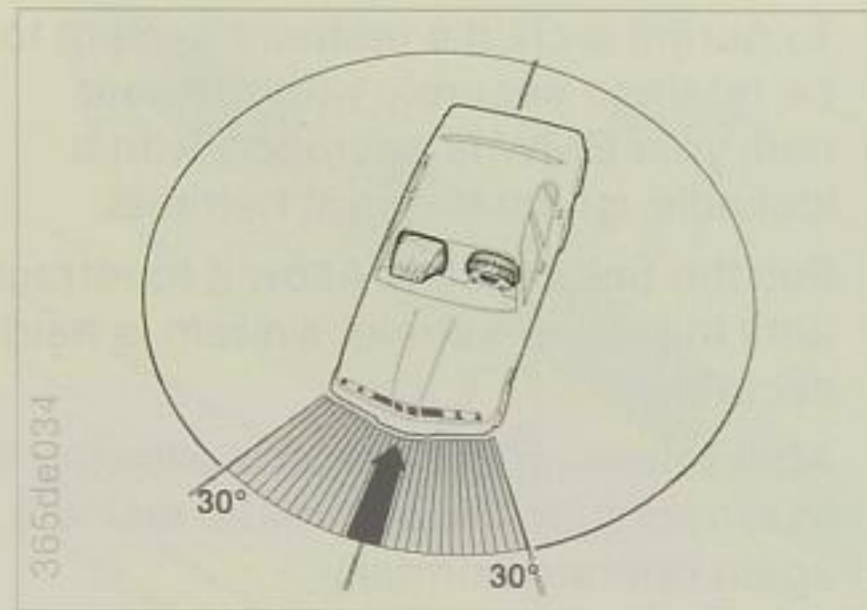

- ▷ Driver's airbag
- ▷ Passenger's airbag

The airbag restraint systems protect the driver/front passenger in a severe head-on collision. The inflated airbag restrains forward movement of the seat's occupant and protects his or her head and upper body against injury.

The picture shows the area within which the airbag restraint system is triggered off.

In less severe accidents and if the car rolls over, is sideswiped or struck from the rear, protection is provided by the seat belt alone.

 The airbag is an additional safety device. It must not be regarded as an alternative to wearing the seat belt. ◀

Telltale light



From ignition key position 1 on, the telltale light confirms that the system is operational.

System operational:

- ▷ The telltale comes on for about 6 seconds or 2 seconds* and then goes out.

System defective:

- ▷ The telltale light does not come on.
- ▷ The telltale comes on for about 6 seconds or 2 seconds*, goes out briefly and then comes on again.
- ▷ The telltale flashes for 5 minutes during a journey, then remains on permanently.
- ▷ The telltale remains on permanently* or flickers*.

If there is a system fault, there is a risk that it will not be triggered off even if a sufficiently severe accident occurs within the airbag range.

Please have it checked by BMW Service without delay.



The airbag telltale light also comes on if the belt catch tensioner is triggered off. ◀

What happens when the system is triggered off?

The airbags, which are concealed under the flaps in the steering wheel or in the fascia, are inflated rapidly and burst out of the preformed aperture in the padded covers.

The entire process takes place with great force, within only a twentieth of a second.

In view of the system's very brief response time, the noise of propellant ignition, inflation and subsequent deflation is lost in the general accident situation.

Propellant gas and small quantities of gaseous fumes are released when the airbag is triggered off. They do not represent a health hazard or imply that the car has caught fire.

The sudden increase in pressure inside the car when airbags are inflated may temporarily impair the occupants' hearing.

Airbags



Your seated position should be as far as convenient from the steering wheel or fascia.

Always hold the steering wheel by its rim. Failure to drive in this manner could result in hand or arm injuries if the airbag operates.

No objects should be held or allowed to rest between the airbag and the seat occupant's body.

Always wear your seat belt on every journey. The airbags are additional safety devices, and must not be regarded as an alternative to wearing the seat belt. Please note that in less severe accidents or if the car rolls over or the impact takes place at the side or the rear, protection is only provided by the seat belt.

Child restraint systems mounted on the front passenger's seat are not permitted on cars with a front-passenger airbag. In certain countries it is in any case required by law that children under the age of 12 should only travel on the rear seats.

Even if all the appropriate precautions are taken, the risk of facial injuries when airbags are triggered off cannot be entirely ruled out in all accident situations. ◀

Airbag safety instructions

The airbag restraint system's gas generator must not be removed from the car. Any testing and assembly work on it may only be carried out by specially trained personnel. In the event of malfunctions of the airbag system, if the car is laid up out of use or if the airbag system was triggered off in an accident, BMW Service must be entrusted with the necessary repair or removal work.

No modifications to individual components or to the wiring should be attempted. This includes the padded cover in the centre of the steering wheel and the cover on the instrument panel, which must never be covered with adhesive or any other material or modified in any way. The steering wheel itself must not be taken off.

In order to comply with valid safety regulations, the airbag generator must only be scrapped by BMW Service.

Any careless or unskilled interference with the system could lead to its failure or to accidental triggering off with the risk of injury.



The driver should inform your passengers about the airbag restraint system and ensure that they comply with the necessary precautions. ◀

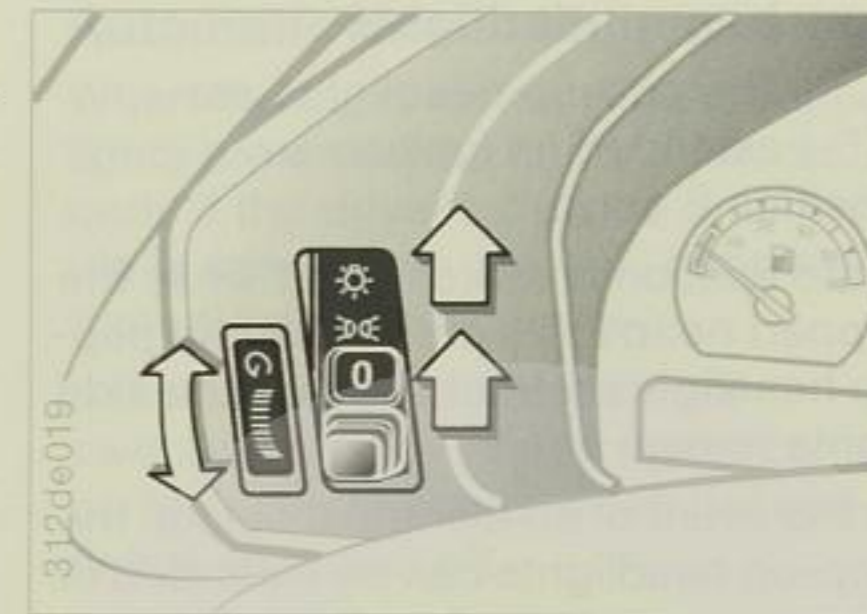

Daytime lights setting*

 If desired, the light switch can remain in this position: when the ignition is turned off, the car's lights go out.

On vehicles fitted with the daytime lights setting*, the daytime lights come on automatically in ignition key position 2 even if this switch setting is not used, and if the light switch is at 0.

Side lights



Low beam headlights

 The pop-up headlights are extended (in ignition key position 2 only).

If the ignition is switched off while the dipped headlights are in use, the pop-up headlights retract and only the side lights remain on.

In the event of an electrical defect, the pop-up headlights can be extended or retracted manually. See Page 115.

Instrument lighting

The intensity can be varied at the knurled wheel.

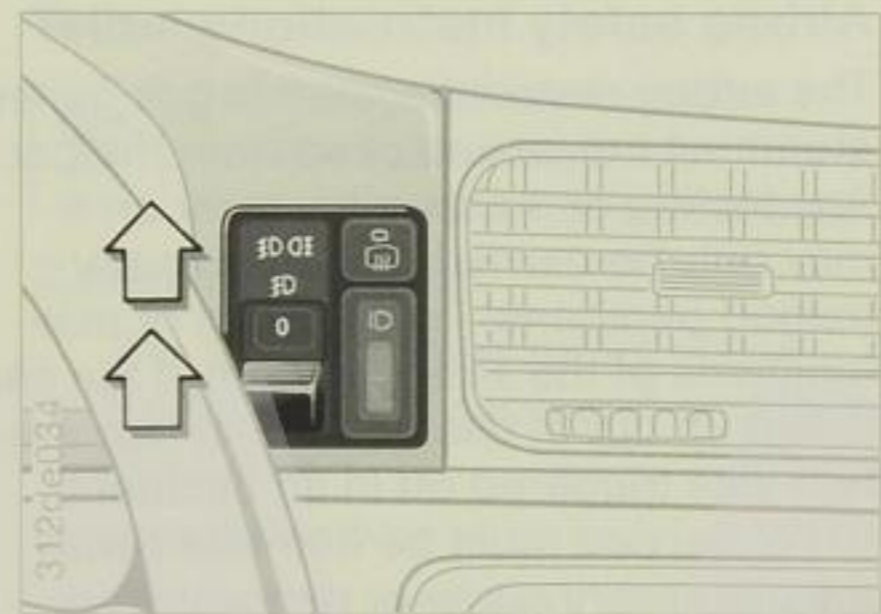
Fog light switches**Fog lights**

 The green telltale light on the instrument panel comes on when the fog lights are in use.

Front and rear fog lights

 The yellow telltale light on the instrument panel comes on additionally when the rear fog lights are in use.

Please comply with local legislation concerning the use of front and rear fog lights.

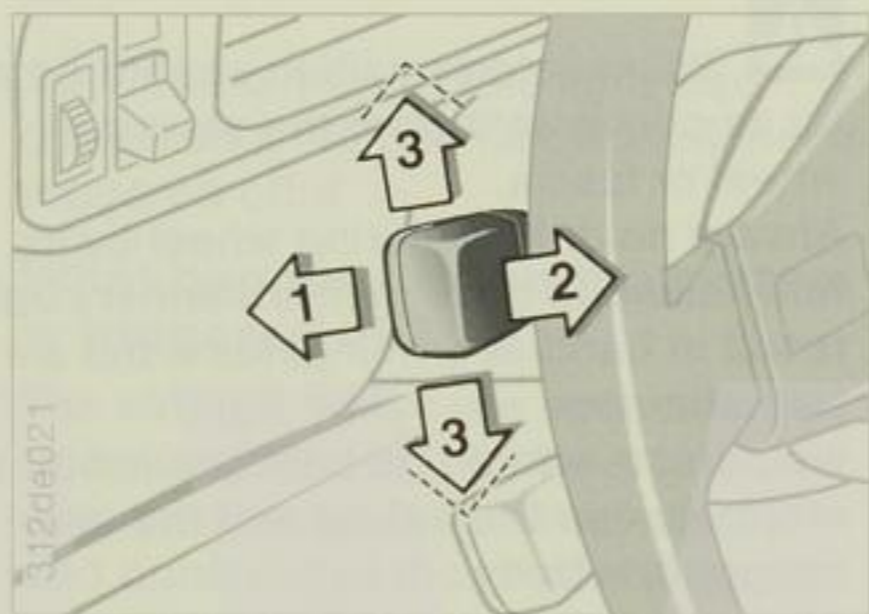
Indicator/headlights

- 1 High headlight beams (blue telltale light)
- 2 Headlight flasher
- 3 Turn indicator repeater (green telltale light, flasher relay ticks rhythmically).

Repeater flashes and relay ticks more rapidly than usual: a turn indicator bulb has blown.

To indicate a turn briefly

Move the lever lightly, only as far as the first detent.

Right or left parking lights

When the steering lock is engaged, press the lever beyond the normal turn indicating position until it reaches a detent.

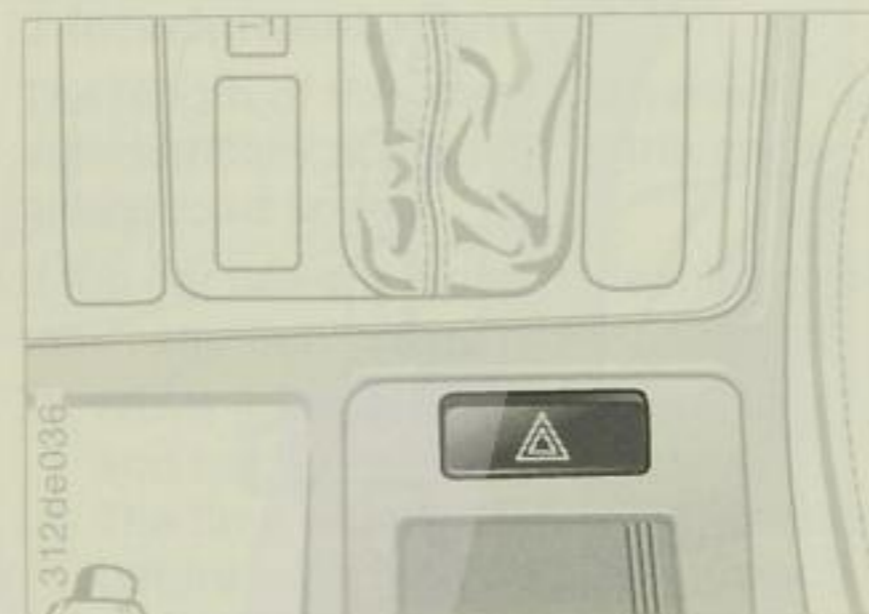
Hazard warning flashers

The pushbutton lights up in a regular rhythm when the hazard warning flashers are operating.

The pushbutton is illuminated when the car's outside lights are on.

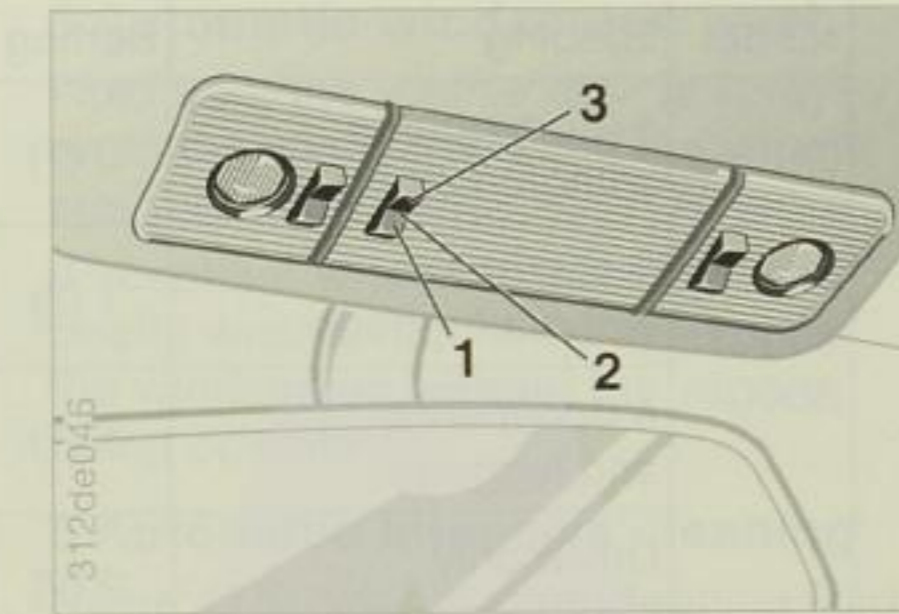
Interior lights/Footwell lights

- 1 Lights on when a door is open
- 2 Lights permanently off
- 3 Light permanently on

Note that the reading lights next to the front interior light are switched on any off in the same way.

Automatic interior light circuit

When the car is locked, the interior lights are switched on for a few seconds if the driver's outside door handle is raised (this can only happen three times in succession).

If the car's outside lights were switched on, the interior lights come on for a few seconds when the ignition is switched off.

A safety circuit ensures that any lights still burning inside the car are extinguished about 15 minutes after the car has been locked and left parked.

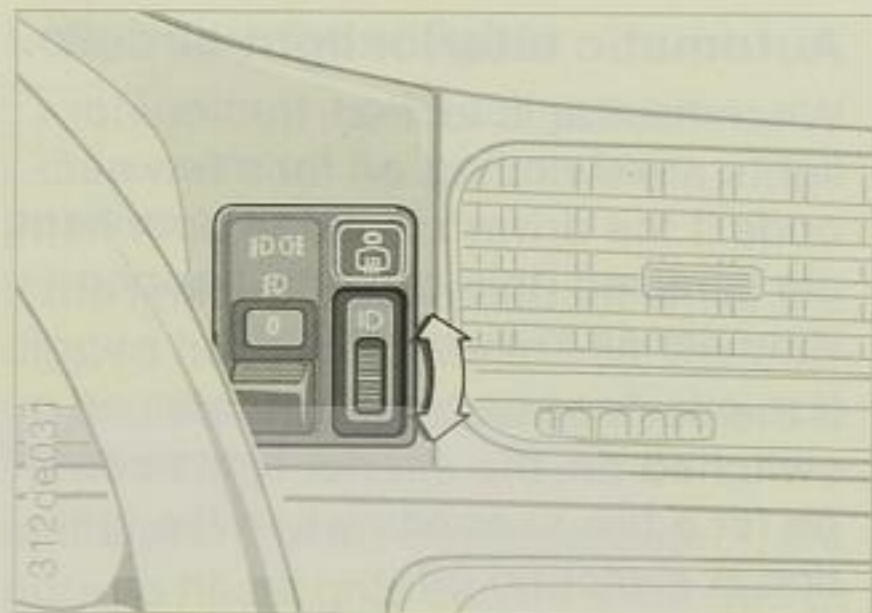

To avoid dazzling the drivers of oncoming vehicles, you must adjust the dipped headlight beam angle to suit the load being carried in the car. Position 0 is for passengers without luggage, and when not towing a trailer (with a trailer = position 1).

For further settings, see the table in the next column.

Model	Loading	Setting
840Ci 850Ci	1-2 occupants without luggage	0 (1)
	4 occupants without luggage	1 (2)
	4 occupants and luggage	1 (1)
	Driver only, max. luggage	2 (2)
850CSi	1-2 occupants without luggage, 4 occupants without luggage	0
	4 occupants and luggage, driver only, max. luggage	1

Figures in brackets () apply when towing a trailer.

Note the permitted rear-axle load limit.

Wipe/wash equipment

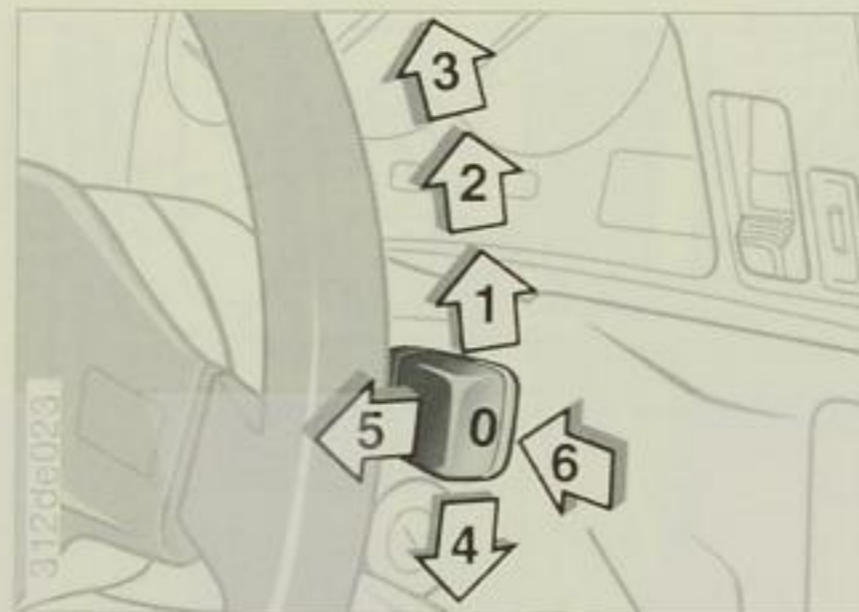

- 0 Wipers parked
- 1 Intermittent wipe
- 2 Normal wiper speed
- 3 Fast wiper speed
- 4 Flick wipe
- 5 Automatic windscreen wash
- 6 Automatic intensive cleaning

0 Parked wiper position

The wipers are partly concealed behind the rear edge of the engine compartment lid. In order to swing the wipers up vertically, for instance to renew the blades or at sub-zero temperatures, lever position 1 should be selected and the ignition switched off as soon as the wipers reach the new position.

Wipe/wash equipment

1 Intermittent wipe

The length of the interval is varied automatically according to the car's actual road speed.

If the car has a headlight cleaning system*, you can also vary this interval:

- ▷ Move the lever briefly from 0 to 1 and back.
- ▷ The time which you allow to elapse before switching on again (from 0 to 1) is the subsequent intermittent-wipe interval (maximum 25 seconds).

This interval setting is cancelled if you return the lever to 0 or when the ignition is switched off.

2 Normal wiper speed

If the car comes to a standstill, the wipers automatically switch to intermittent operation.

3 Fast wiper speed

If the car comes to a standstill, the wipers switch to normal speed.

5 Automatic windscreen wash

Fluid from the washer tank is sprayed on to the windscreen and the wipers are operated briefly.

(Exception: when the lever is pulled briefly, washer fluid is sprayed on to the windscreen without the wipers being operated.)

6 Automatic intensive cleaning

Same as 5, but intensive cleaning fluid is first sprayed on to the windscreen. Changing the wiper blades: see Page 116.

Headlight cleaning*

If the headlights are switched on, they are automatically cleaned as well on each fifth occasion that the windscreen wipers or intensive cleaning system are operated.



Do not use the washer systems if there is any risk of the liquid freezing on the windscreen. This could interfere with the driver's view of the road. Do not run the washer if the fluid reservoir is empty, or else the washer pump will be damaged. ◀

Windscreen washer jets

The windscreen washer jets are automatically heated in ignition key position 2.

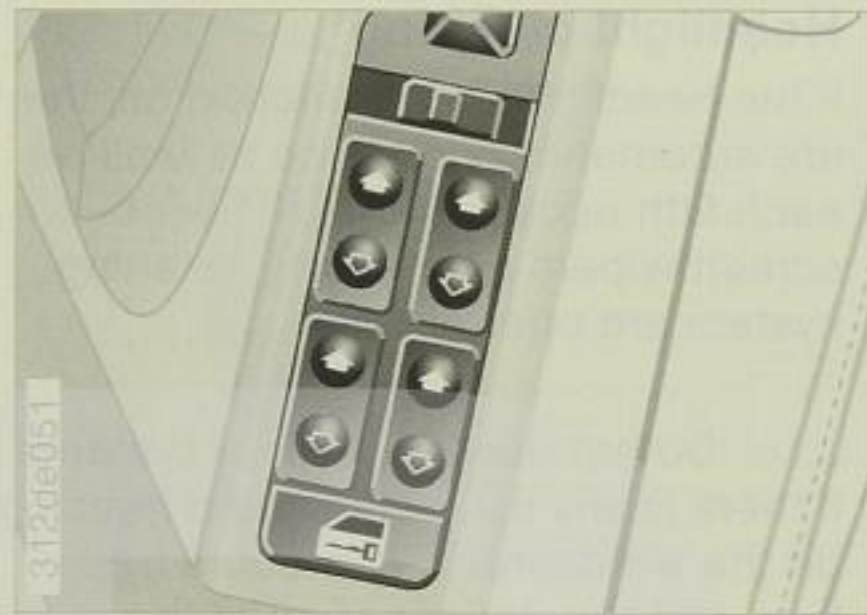

From ignition key position 1:

- ▷ Press the rocker switch in until the pressure point is felt. The window will continue moving until the rocker switch is released.
- ▷ Press the rocker switch in briefly beyond the pressure point (one-touch function*): The window opens or shuts automatically. In this case, window movement is halted by touching the switch again briefly. The one-touch function applies to opening and closing the door windows, but only to opening the rear side windows.

There is a separate rocker switch on the passenger's side.

In ignition key position 0:

After switching off the ignition you can continue to operate the electric windows for up to 15 minutes, provided that neither front door is closed. To open, press the rocker switch beyond the normal pressure point.

Protective function

If a door window encounters an obstruction while closing at a point above approximately half the total vertical movement, the glass will come to a halt and then re-open slightly.

This protective function can be put out of action (e.g. to prevent someone from reaching in from the outside) by holding the switch down in the one-touch operating position.

The system is also protected against overloads and malfunctions by an automatic electronic circuit breaker.

▶ If a door window is open when the car reaches a speed of app. 150 km/h (app. 95 miles/h), it will close automatically to keep the noise level low. However, if the window is then re-opened, this function is put out of action for this particular window until the engine is re-started.

After any power supply interruption, for instance if the batteries are disconnected, the electric window functions must be re-activated: Either close the windows completely or, if already closed, press the corresponding switch once briefly. ◀

Convenient operation of windows at door lock

To open: with the door closed, turn the key to the "open" position and hold it there.

To close: with the door closed, turn the key to the "close" position and hold it there.

Release the key to halt the movement.

For convenient operation of windows by means of the remote control, see Page 30.

⚠ Careless and unsupervised closure of the windows could cause injury. Make quite sure that children cannot operate the switches accidentally. Always remove the ignition key and take it with you when leaving the car. ◀

Sliding/tilt sunroof*

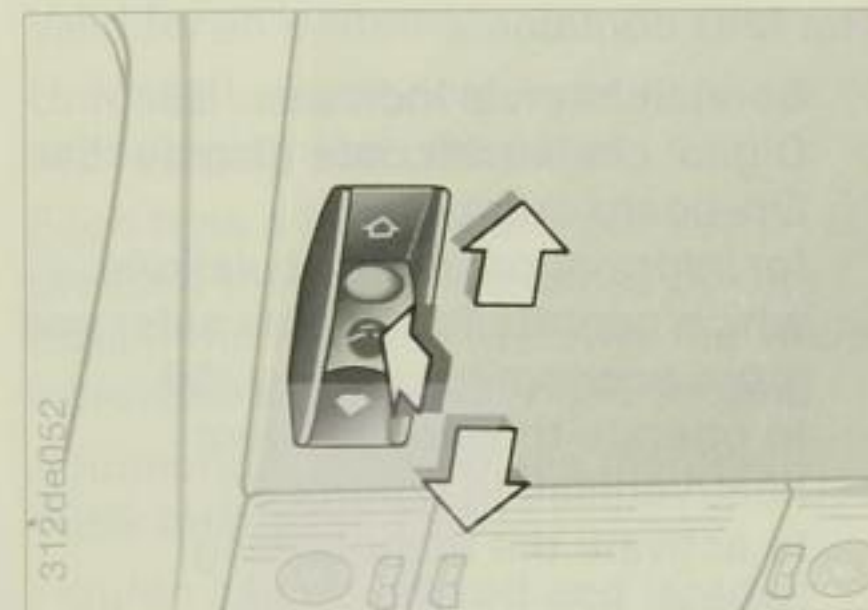

From ignition key position 1:

To raise: press the switch.

To open: slide switch to the rear.

To fasten: slide switch forwards.

▶ When raised, the roof lining moves back only a short distance. ◀

One-touch function*

Sunroof opens or closes automatically if the switch is moved once in the desired direction. Movement is stopped by touching the switch again. The one-touch function cannot close the roof from the raised position.

In ignition key position 0:

After switching off the ignition, you can operate the sunroof for up to 15 minutes, provided that neither of the front doors was closed.

Protective function

If the sunroof panel, when operated by the one-touch function or from a door lock, encounters an obstruction after it has closed about halfway, it will come to a halt and re-open slightly.

After an interruption to the power supply (for example if the batteries are disconnected), the protective function must be re-activated by pressing the switch or sliding it forward and holding it in position until the sunroof panel is fully raised.

If an electrical defect occurs, the sunroof can be operated manually. See Page 115.

An electronic automatic circuit breaker protects the system against overloads and malfunctions.

Convenient operation of the sunroof from the door lock

To open: with the door closed, turn the key to the "Deadlock" position and hold it there.

To fasten: With the door closed, turn the key to the "Engage central locking system" or "Engage deadlock" position and hold it there.

Release the key to halt the movement.

For convenient closure/opening of the sunroof by means of the remote control (see Page 30)

⚠ Careless or unsupervised closure of the sunroof could cause injury. Make quite sure that children cannot operate the switches accidentally. Always remove the ignition key and take it with you when leaving the car. ◀

▶ To prevent low air pressure or draughts inside the car when the sliding/tilt roof is slid back, and in particular when it is tilted up, keep the ventilation system's air outlets open and boost the airflow through them if necessary. ◀

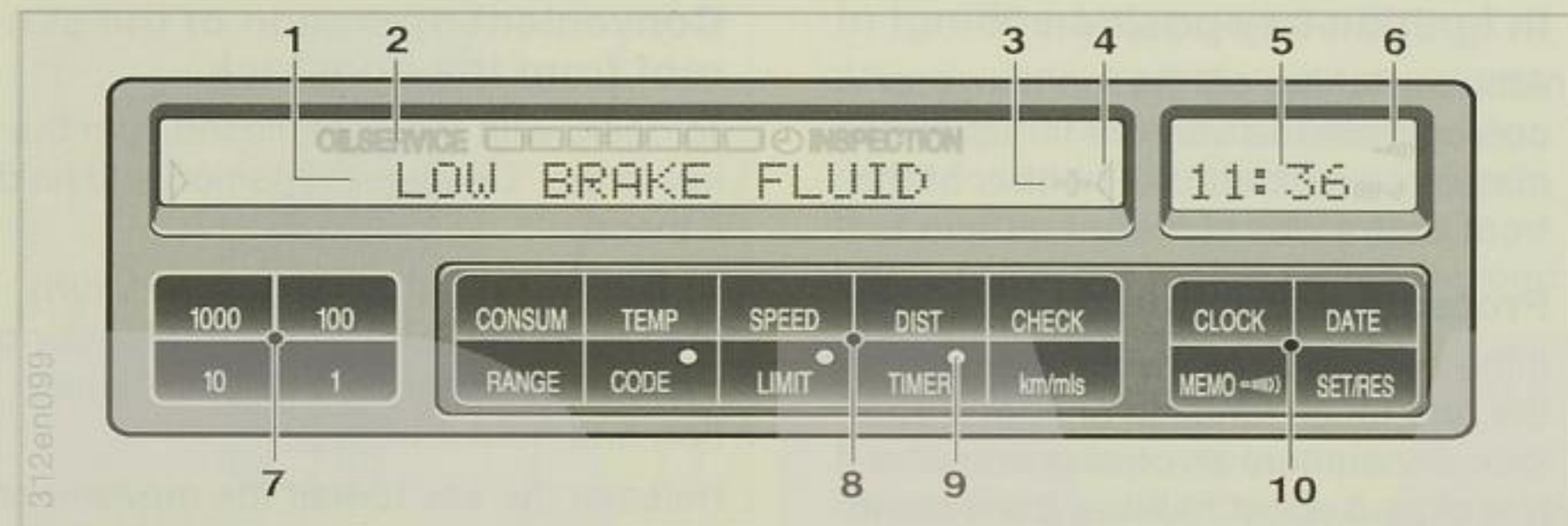

- | | |
|---------------------------------------------------------|-------------------------------------------|
| 1 Display | 6 Sound-wave symbol for reminder function |
| 2 Service Interval indicator | 7 Numerical input keys |
| 3 Plus signs indicate that further displays are present | 8 Information keys |
| 4 Symbol that a warning is present | 9 Light-emitting diodes (LED) |
| 5 Digital clock | 10 Function keys |

The MID contains:

- ▷ Service Interval indicator 53
- ▷ Digital clock with date display 54
- ▷ On-board computer for information and calculations which contribute towards safer and more economical driving 56
- ▷ to operate the independent heat/ventilation control 60
- ▷ to activate the immobilising device 62
- ▷ Check Control 64

Explanations and operating instructions for the various functions and displays are given on the following pages.

MID

Valid for all systems:

Unrealistic numerical inputs are not accepted by the computer.

Each time a numerical input key (7) is pressed the value increases by one digit. If the key is held down, the value increases by one every half second.

A numerical input erases the previously memorised one.

Figures can be altered and input in any convenient order.

The value is input to the memory by pressing the SET/RES key.

To clear the display, press the CHECK button.

If the power supply is interrupted, for instance when a battery is charged, all the memorised data are erased. After restoring the power supply the time, date and any previously stored switch-in times, distance and speed limit values must be input again.

If the "PPPP" fault display appears, consult BMW Service.

Service Interval indicator

Green light-emitting diodes

The fewer are on, the sooner the next service will be due.

Yellow LEDs

This lights up in conjunction with OILSERVICE or INSPECTION.

comes on when service work is due.

Red LEDs

Maintenance work is overdue.

Clock symbol with INSPECTION display

Shows that brake fluid renewal is due.



Periods during which the battery has been disconnected are ignored by the display.

Make sure that brake fluid is renewed every two years, regardless of whether this is confirmed by the display.

Further details: Page 99. ◀

All displays go out after the engine has been started.

The BMW Service station resets the Service Interval indicator to the original display after the maintenance work has been carried out.

For further details, please see Page 138 and refer to the car's Service Booklet.

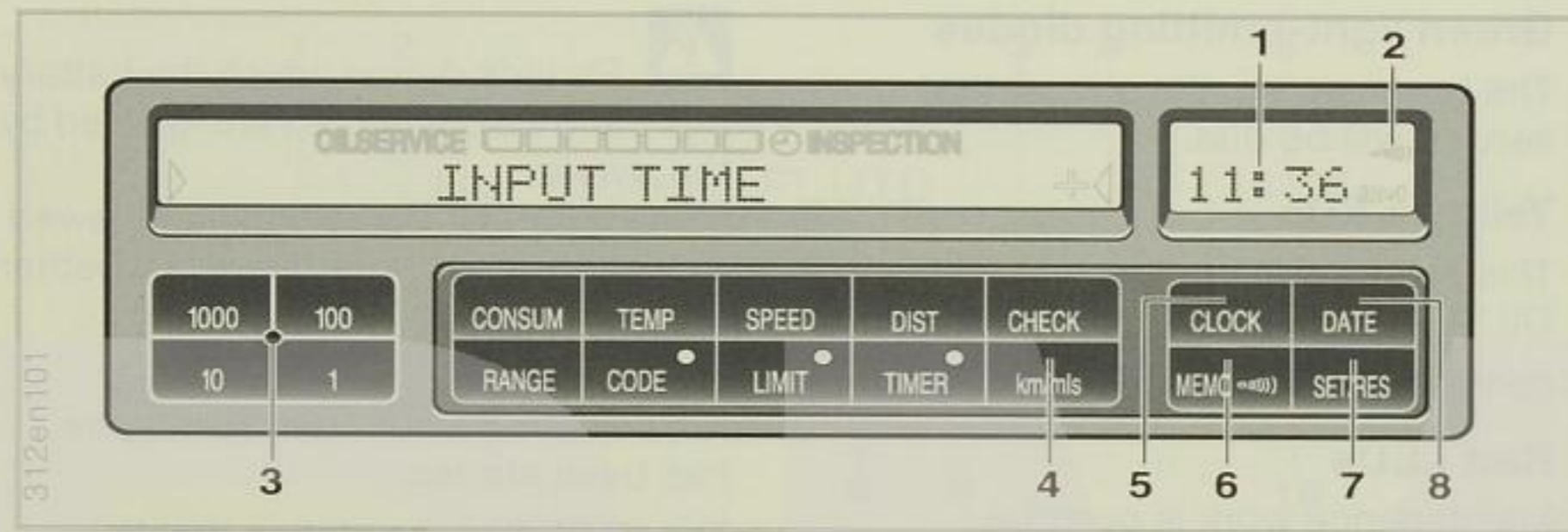

- 1 Digital clock display
- 2 Symbol for memo function
- 3 Numerical input keys
- 4 Display unit changeover key
- 5 Clock function key
- 6 Memo function key
- 7 Start/Stop key
- 8 Date function key

The digital clock can be used to

- ▷ call up the time and date
- ▷ program a reminder signal (Memo) every hour, for instance so that radio news bulletins are not missed.

Calling up time and date

Press the appropriate function key (5/8).

In ignition key position 0 or with the ignition key removed, the display appears for a few seconds only; in ignition key position 1 and beyond, the value remains on display.

You can have the time displayed as a 12- or 24-hour clock and the date in European or American order. Change-over:

Press the function key (either TIME OR DATE) and the display units changeover key (km/mls) at the same time.

When the 12-hour clock is in use, the letters AM or PM appear at the right of the display.

Memo function

Press the MEMO key to switch this function on and off.

The signal is heard 15 seconds before every full hour. A sound-wave symbol appears in the clock display to indicate that the MEMO function has been selected.

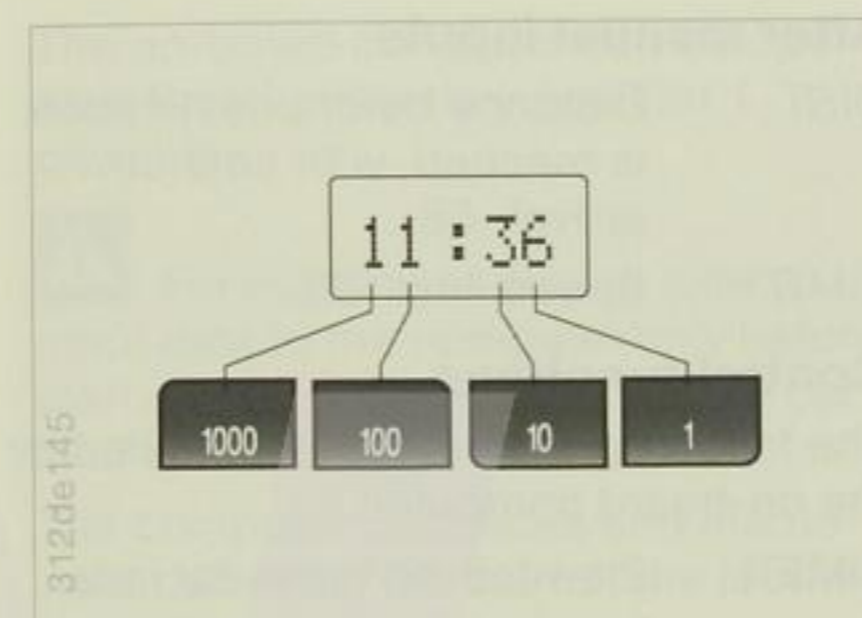

Inputs

All time and date settings are made by way of the numerical input keys, according to the following principle:

The digits can be input in any order. Each time a key is pressed, or if it is held down for half a second, the value increases by one.

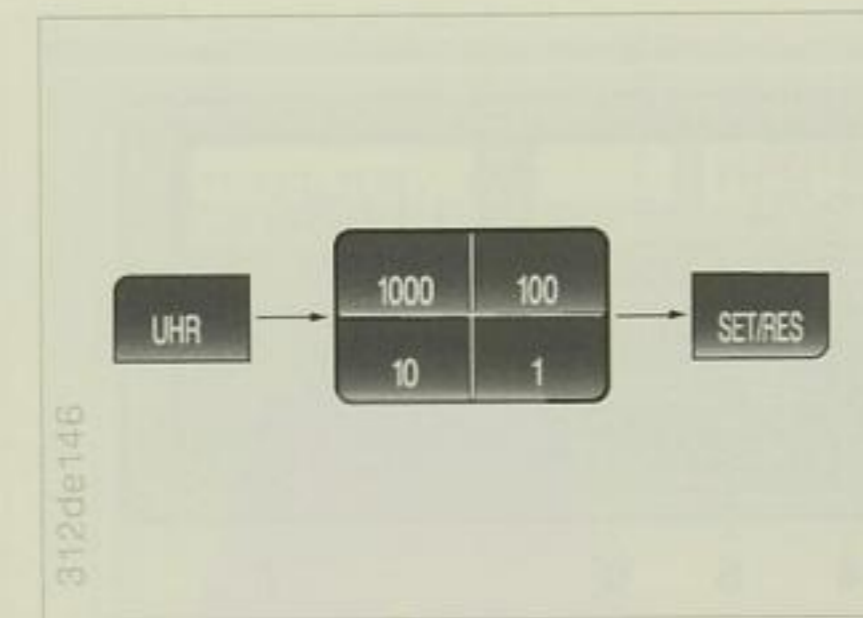

Altering the time display

Press the TIME key until the MID displays INPUTTIME and the time display flashes.

Altering the date display

Press the date key until the MID displays INPUT DATE and the date display flashes.

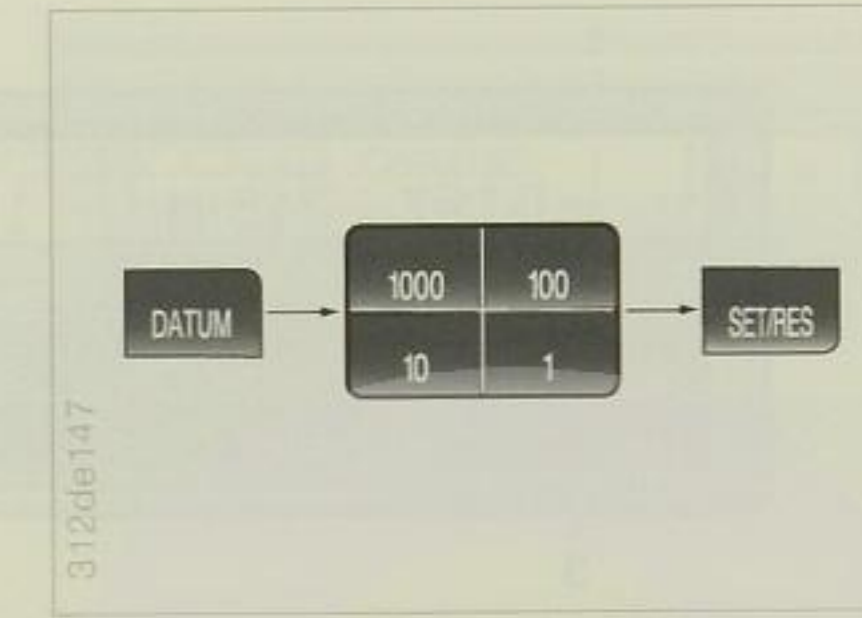

If necessary, input the year before pressing SET/RES, if the display calls for this input (INPUTYEAR). (The device takes leap-years into account, so that no special manual adjustment is necessary.)

After a power supply interruption

The time display flashes and the MID displays INPUTTIME.

- ▷ Input the time at the numerical input keys.
- ▷ Press SET/RES. The clock will start to run.

The MID displays INPUT DATE.

- ▷ Input the correct date at the numerical input keys.
- ▷ Press SET/RES.

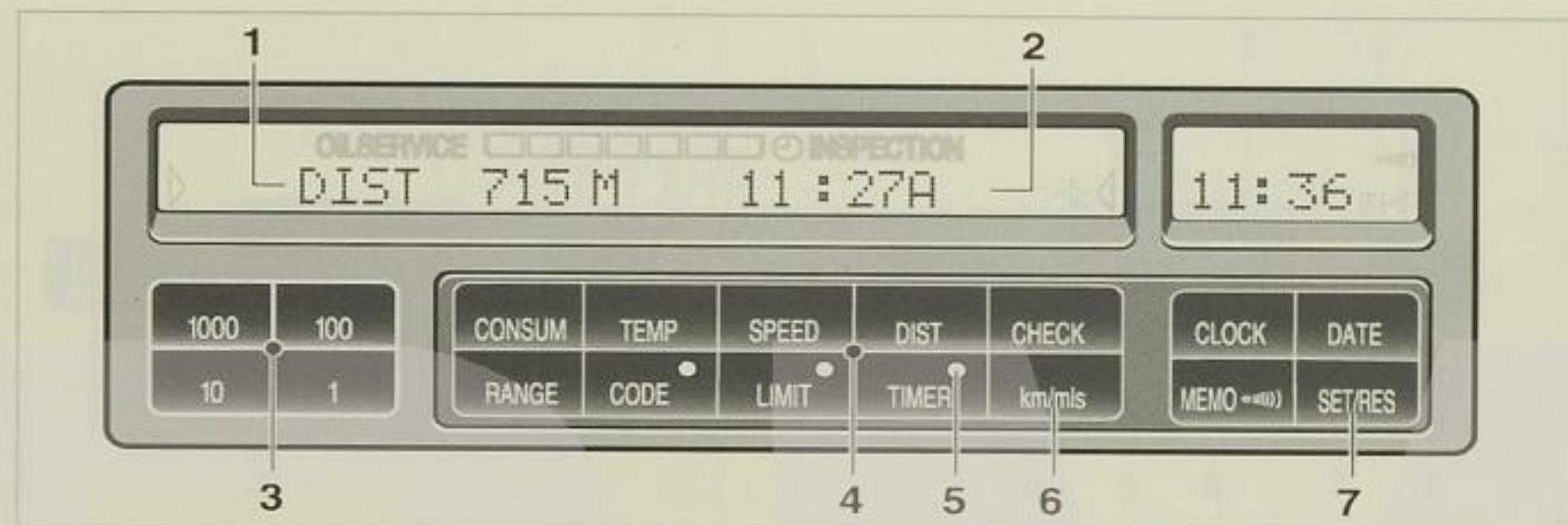

- 1 Display
- 2 Time of arrival
- 3 Numerical input keys
- 4 Information keys
- 5 Light-emitting diodes (LED)
- 6 Display unit changeover key
- 7 SET/RES key (start/stop)

The on-board computer can be used to call up and display information which contributes to safe, economical driving.

Data available without previous inputs

TEMP	Outside temperature	57
RANGE	Probable range	57
SPEED	Average speed	58
CONSUM	2 average fuel consumptions	58

After manual inputs

DIST	Distance before destination is reached, with time of arrival	58
LIMIT	Speed limit	59

Control functions

The following systems are controlled by the on-board computer:

TIMER	2 switch-on times for independent heater/ventilation control	60
	Direct operation of heater/ventilation control	61
	Stopwatch	60
CODE	Immobiliser	62

On-board computer

The on-board computer can be operated from ignition key position 1 onwards.

! For reasons of driving safety, input data to the computer only before starting your journey or when the car is at a standstill. ◀

The computer calculates and memorises data from the start of the journey onwards.

Information can also be displayed by operating a remote control; see Page 63.

The changeover key (6) enables information to be displayed either in metric or Imperial units of measurement.

▶ Check Control warnings displace the computer displays. ◀

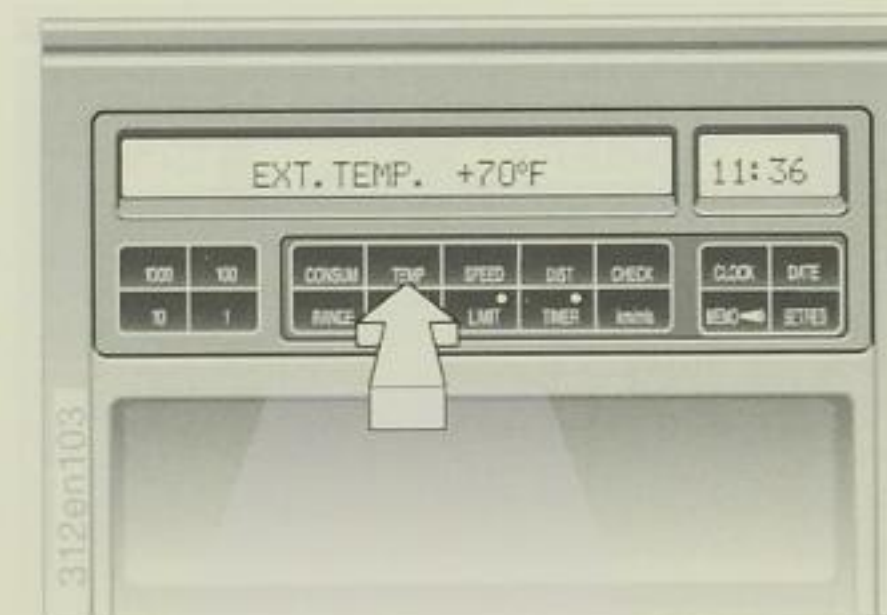

Outside temperature

To display: Press the TEMP button.

If the outside temperature falls below +3 °C, a gong signal is heard as a warning; the outside temperature is displayed and flashes for 8 seconds.

The warning is repeated if the temperature rises to at least +6 °C and then drops again to +3 °C.

! Whether or not a temperature warning is given, remember that ice can still form on the road at above +3 °C in certain circumstances, for instance on bridges and in shadow. ◀

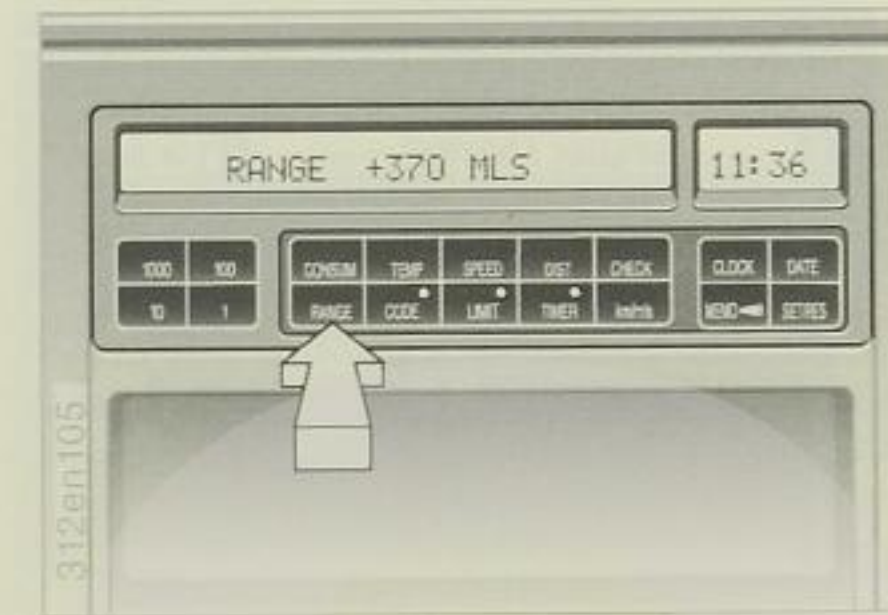

Probable range

This display indicates how far the car can probably be driven on the fuel remaining in the tank. The value takes into account the way in which way the car has so far been driven.

To display: Press the RANGE button. A plus sign (+) in front of the value means that it is still being corrected (measuring tolerance).

If three display segments flash, the range is below 15 km (app. 9 miles) and the car should be refuelled as soon as possible.

The on-board computer registers fuel added to the tank only

- ▶ if the quantity exceeds 4 litres and
- ▶ when the engine has been stopped.

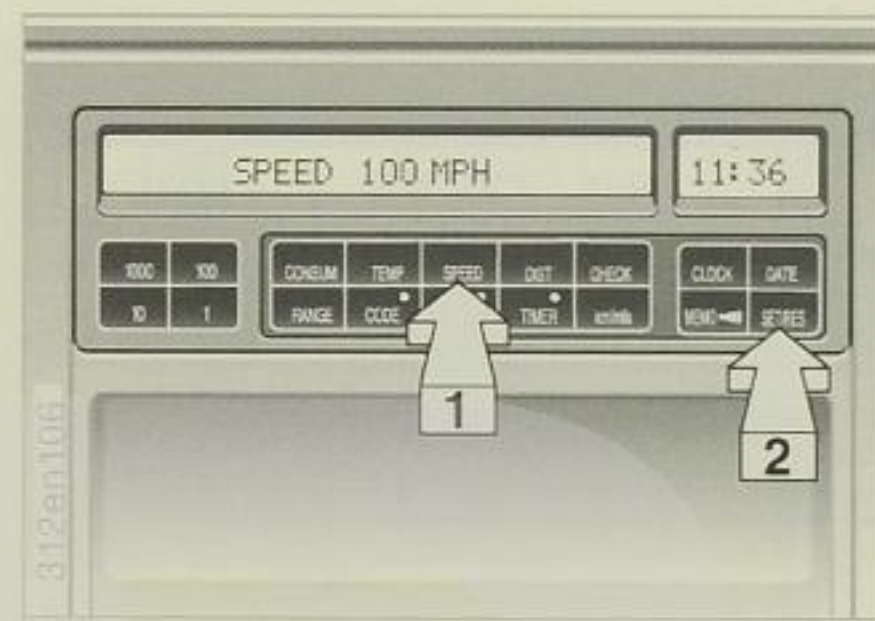

Average speed

To start computing:

Press the keys in the order illustrated.

To display: press the SPEED key.

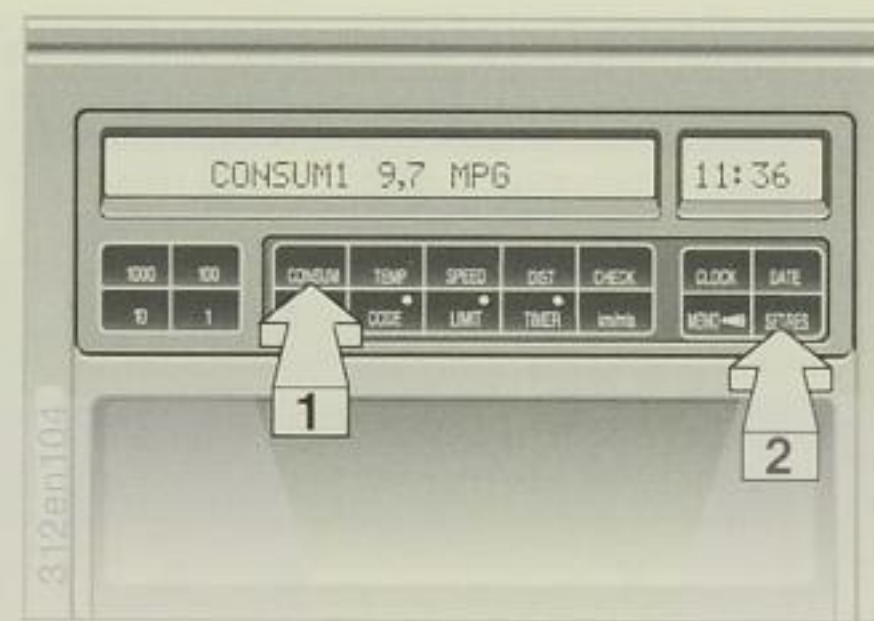

Average fuel consumption

Average fuel consumption can be computed for two distances in parallel, for instance a complete journey and one section of the journey.

To start computing for distance 1:
Press the keys in the order illustrated.

To start computing for distance 2:
Press the buttons again in the order illustrated.

To display: Press the CONSUM button.

Each time this button is pressed, the display alternates between the average consumptions for distances 1 and 2. There is also an indication of whether distance 1 or 2 is being displayed.

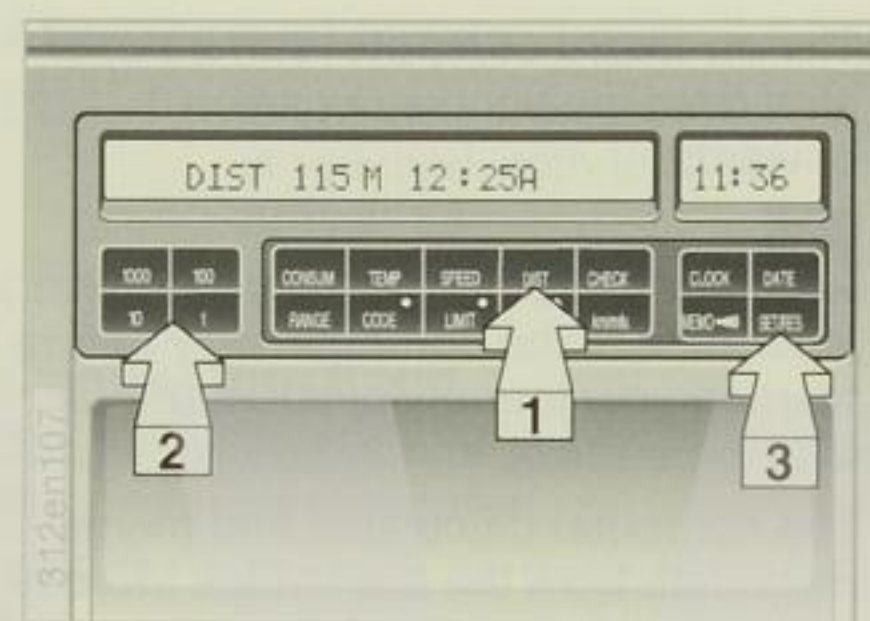

Distance from destination

This shows how far the car is from the destination, provided that the total distance was input before the journey started.

Distance input:
Press the keys in the order illustrated.

To display:
Press the DIST button.

The probable time of arrival, which is recalculated continually as driving conditions change, is also displayed.

If the car has already completed the full distance which was input at the start of the journey, the distance value is preceded by a minus sign.

On-board computer

Display units changeover:
Press km/mls changeover key

- ▷ to alter the distance display or twice
- ▷ to alter the arrival time display also.

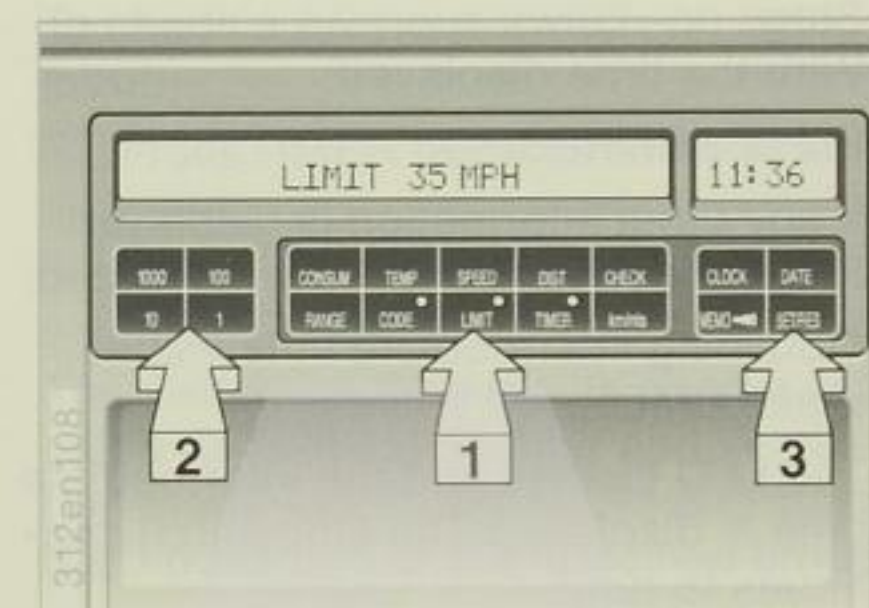

Speed limit

If you exceed a speed limit which you have previously input (for instance in order not to infringe the legal speed limit), a warning will be given. The corresponding LED flashes and the display shows the stored limit briefly.

The warning is only repeated if the car's speed drops by at least 5 km/h and the speed limit is subsequently exceeded again.

Speed limit input:

Press the keys in the order illustrated.
The LED will come on.

Cancelling the speed limit input:
Press the LIMIT button again.

The LED goes out, but the stored value is not lost and can be re-activated with the LIMIT button.

Adopting the car's actual speed as the limit value:
Press the LIMIT and SET/RES button.

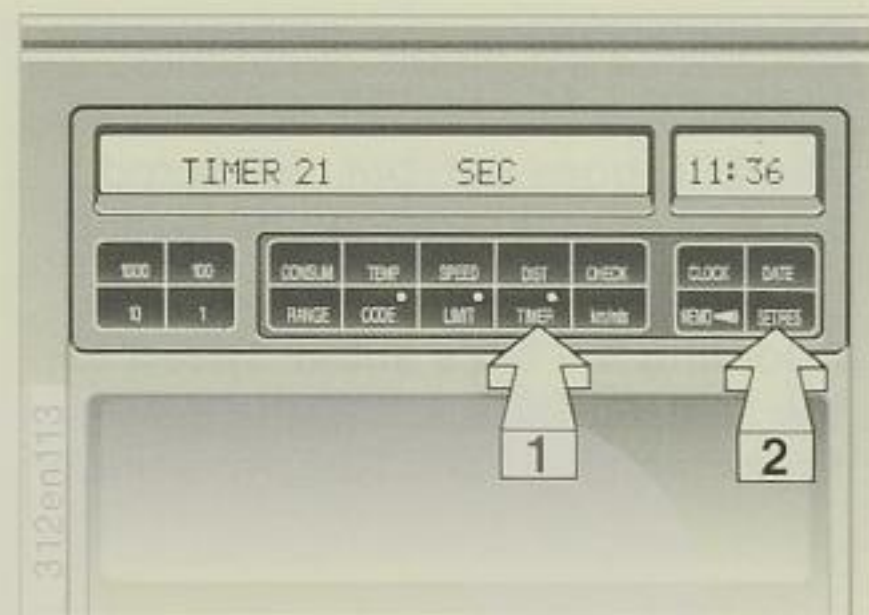

Stopwatch*

The stopwatch function is only available on cars without independent heater and ventilation control. It runs for 99 hours, 59 minutes. The time appears in the display: at first in seconds and tenths of a second, after one minute in minutes and seconds, and after one hour in hours and minutes.

Start:

Press the keys in the order illustrated. The LED comes on and the cumulative time is shown in the display.

Stop:

With the time displayed:

Press SET/RES.

If any other information is displayed: Press the keys in the order illustrated.

Obtaining intermediate time value: press TIMER.

The LED flashes and the intermediate time is displayed. The stopwatch continues to run.

Obtaining main stopwatch time display again: press TIMER again.

▶ The stopwatch ceases to run in ignition key position 0, but runs again in ignition key position 1. ◀

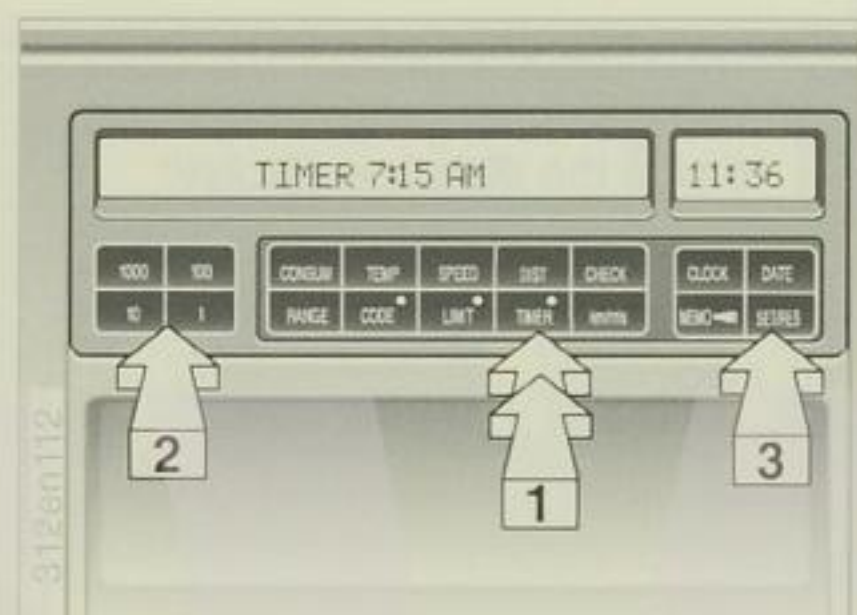

Independent heater* /Programming independent ventilation

Input of switching times:

You can preselect two switch-on times for the independent heater or ventilation control. The function depends on outside temperatures: the heater can be operated below 16°C, the ventilation above 16°C. The heater or ventilation is switched off again automatically after 30 minutes.

For important information on operating the independent heater/ventilation controls, see Page 82.

When the TIMER button is pressed, the display shows the current operating condition of the independent heater/ventilation control.

Input of first switch-on time:

Input is possible only if the digital clock is running and the ignition key is in position 1.

Press the keys in the order illustrated. (press TIMER twice).

Input of second switch-on time: press the keys again as illustrated, but press TIMER only once.

Correcting the time input:

Press the keys in the order illustrated, including the different time input. After the input, the display shows * and the LED comes on as a reminder that a switch-on time has been preselected. The LED flashes while the heating or ventilation is actually in operation, and goes out when they are switched off.

To check a previous switch-on time input:

- ▶ Press TIMER twice for the first time input.
- ▶ Press TIMER three times for the second time input.

The switch-on time inputs can be activated as follows: heating and ventilation starts – LED comes on) and stops (LED goes out) at the specified times: press SET/RES after selecting the desired switch-on time.

The switch-on times remain stored until cancelled by a new input.

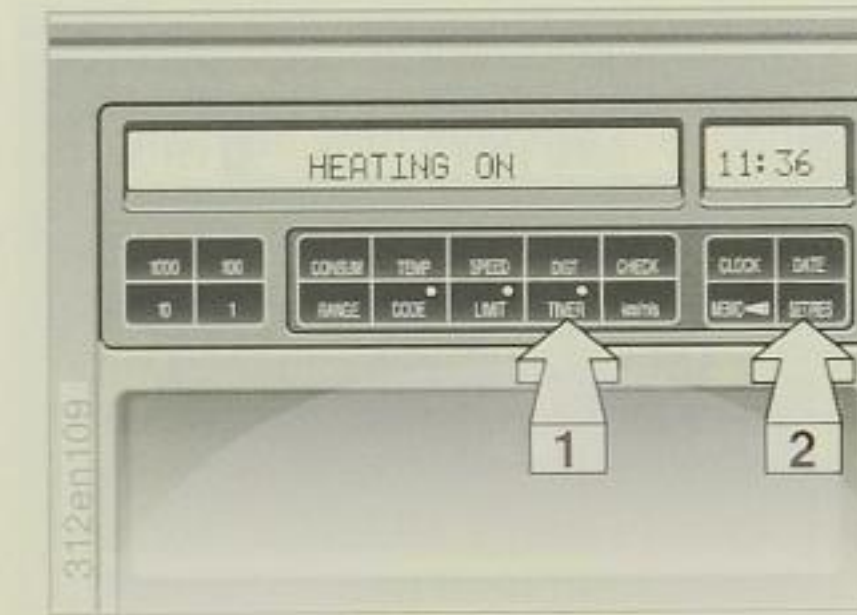

Direct switch-on of independent heating/ventilation control

This is only possible in ignition key position 1. Press the keys in the order illustrated.

Direct switch-off of independent heating/ventilation control

In ignition key position 1 – press the keys in the order illustrated.

In ignition key position 0 or 1, press SET/RES only.

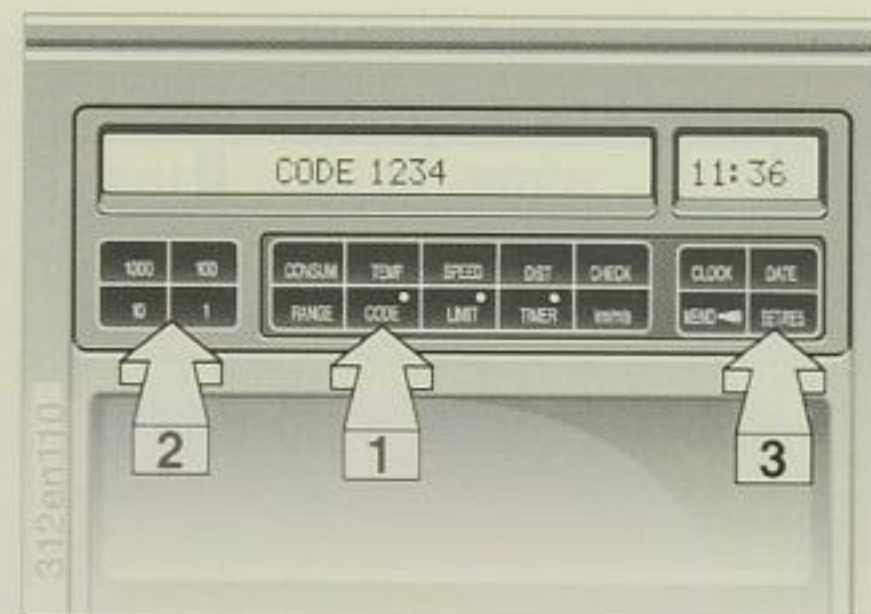

Immobiliser

The engine compartment lid, radio and any attempts to start the engine are monitored.

The device is activated with a code number. Starting the engine, removing the radio or opening the engine compartment are then impossible unless the code number is input incorrectly. For this reason: always remember the code number you have chosen!

Activating in ignition key position 1: Press keys in the order illustrated, then turn ignition key to position 0 and remove.

Any code number from "0000" to "9999" can be input. (The same or a different code number must be input each time the device is activated.)

In ignition key position 0 or with the key removed, the LED will remain on for up to 36 hours. If the LED flashes for about 10 seconds, the engine compartment is not properly closed or the radio removed.

De-activating in ignition key positions 1 or 2:

The gong signal and the "----CODE" display call for the driver to input the chosen code number.

- 1 Input the code number at the numerical input keys.
- 2 Press SET/RES.

If attempts are made to start the engine without a code input or if the incorrect code is entered, the gong will sound and the engine will not start.

If the code number has been forgotten, proceed as follows:

- 1 Disconnect the battery, then reconnect it. The alarm will sound.
- 2 Turn the ignition key to position 1. A time display will appear and run down for 15 minutes.
- 3 After 15 minutes, the engine can be started.

If the code number becomes available again during this 15-minute waiting period: Press the keys in the order illustrated.

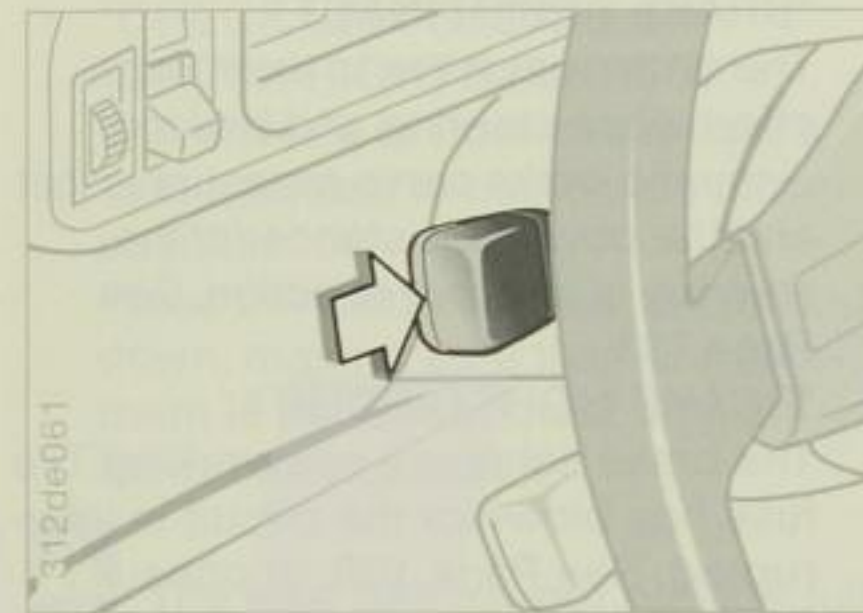

Remote control

The flashing turn indicator lever can also be used to display on-board computer information.

You must first program the items of information you wish to have displayed.

Input:

- 1 Press the turn indicator lever in until the display shows PROG 1.
- 2 Press the computer information buttons for the displays you need. The program number appears in the display for each input.
- 3 Press SET/RES.

If you wish all the information to be accessible:

- 1 Press the turn indicator lever in until the display shows PROG 1.
- 2 Press SET/RES.



The following should be noted in connection with average fuel consumptions 1 and 2 and switch-on times 1 and 2 for the independent heater/ventilation control: to show both consumption figures, the CONSUM button must be pressed twice. To obtain only CONSUM 2, for example, but not CONSUM 1, press the CONSUM button and then the km/mls changeover button. (Each time the changeover button is pressed, the display will alternate between average fuel consumptions 1 and 2.) Adopt the same procedure for independent heater/ventilation control switch-on times 1 and 2 if required. ◀

To display:

Press the turn indicator lever in briefly as often as necessary.

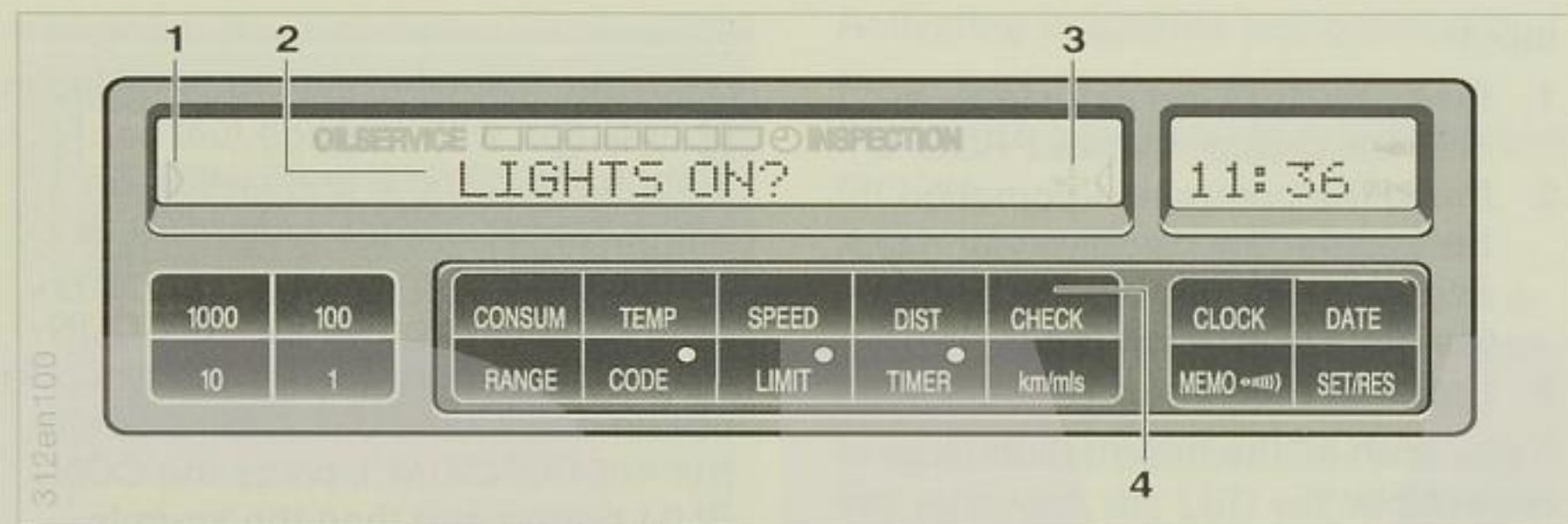

System malfunctions are shown in plain text, and a gong warning sounded. There is also a general warning light on the instrument panel which comes on during the journey if a fault signal is present.

- 1 Symbol that a warning is present
- 2 Display
- 3 Plus sign for further fault displays
- 4 CHECK button

A system of 3 priority categories has been adopted for the fault signals:

Priority 1

These faults are shown immediately with a gong signal and flashing indication in the display (1). If several faults develop simultaneously, they are displayed in succession. These displays remain active until the fault is rectified, and cannot be cleared with the CHECK button (4).

- ▷ "HANDBRAKE ON"

This signal appears shortly after the car has begun to move.

- ▷ "BRAKE ASSIST INACT." The driver may have to exert extra effort when steering and braking, since the brake servo pressure is lost and the power assistance for the steering is also out of action. See Page 103.
- ▷ "BRAKE LIGHT CIRCUIT" The brake lights are not working. The fuse has blown or the circuit is interrupted. See Page 106, or consult BMW Service.
- ▷ "BRAKE LIGHTS FAILURE" The brake lights themselves have failed – the bulbs have blown. Renew defective bulbs. See Page 119.
- ▷ "LOW BRAKE FLUID" The level is close to the minimum mark. Top up at the earliest opportunity. See Page 99. Have the cause of the brake fluid loss rectified by BMW Service.
- ▷ "ENGINE OILPRESS LOW" Engine oil pressure has dropped too low. Stop the car immediately and switch off the engine. See Page 16.
- ▷ "COOLANTTEMPERATURE" The temperature is too high. Stop the car immediately and switch off the engine. See Pages 19, 100.

- ▷ "CHECK LEFT BACKREST" "CHECK RIGHT BACKREST" The driver's or front passenger's seat backrest is not locked into position. Press the seat back rearwards and down, making sure that its movement is not obstructed, until it locks into position.



The seat belt cannot provide full protection unless the seat back is correctly locked into position. ◀

- ▷ "CATALYST OVERHEAT" Stop the car and allow it to cool down until the display goes out. If necessary, consult BMW Service.
- ▷ "SPEED LIMIT" Displayed if the car is driven faster than the maximum national speed limit. Comply with all applicable regulations.

Priority 2

These malfunctions are displayed in ignition key position 2 (but priority 1 signals are automatically superimposed). After the text displays have gone out, symbols remain visible to indicate that there are fault messages in the Check Control. If the plus sign (3) appears, further signals are present – and can be displayed by pressing the CHECK button.

- ▷ "CHECK BACKREST LOCK" The seat back lock sensor is defective. Consult BMW Service.
- ▷ "POWER STEERING FLUID" Level in fluid reservoir too low. See Page 98.
- ▷ "R/AXLE FAILSAFE PROG" The Active Rear Axle Kinematics (ARK) have cut out as a result of a fault. The car can still be driven. If the steering wheel is slightly off-centre when driving in a straight line, the car will veer slightly from the chosen line of travel. See Page 129.
- ▷ "BOOTLID OPEN" Appears only when the car is driven away for the first time.
- ▷ "1 BRAKE LIGHT FAIL" One brake light bulb has blown. See Page 119.

- ▷ "LOW BEAM FAILURE" "SIDE LIGHT FAILURE" "TAIL LIGHT FAILURE" "F/FOG LIGHT FAILURE" "R/FOG LIGHT FAILURE" "NUM PLATE LIGHT FAIL" In each case the bulb or the fuse has blown, or the circuit is defective. See Page 106, 117, or take the car to BMW Service.
- ▷ "TRANS FAIL-SAFE PROG" Defective electronic control unit on automatic transmission cars. See Page 71.
- ▷ "BRAKE LININGS" The brake pads are worn. See Page 103.
- ▷ "WASHER FLUID LOW" Top up at the next opportunity. See Page 101.

Priority 3

Displayed primarily at the end of the journey in ignition key position 0 (if several signals are present, they are displayed in succession, but priority 1 and 2 signals take precedence over priority 3).

Even with the ignition key removed and the display blank, you can recall fault signals with the CHECK button for up to 2 minutes, provided that the car's doors remain closed.

You can also call up fault signals in ignition key position 2 before a journey is started. The displays go out after a short time or when the car is driven away, and no indicating symbols remain visible.

The signals are repeated only in ignition key position 0.

If a plus sign is visible: call up further fault signals by pressing the CHECK button.

- ▷ "CHECK ENGINE OIL LEV"
Engine oil level has dropped to near the permissible minimum. Add oil at the next opportunity (for instance when refuelling). See Page 96.

- ▷ "LIGHTS ON?"
Displayed at the end of the journey (when the driver's door is opened).
- ▷ "KEY IN IGNITION LOCK"
A gong signal is also heard.
- ▷ "FASTEN SEAT BELTS*"
The telltale light with seat belt symbol also comes on.

To test the Check Control display (only when no signals are shown):

In ignition key position 2, press the CHECK button: the display should show CHECK CONTROL O.K.

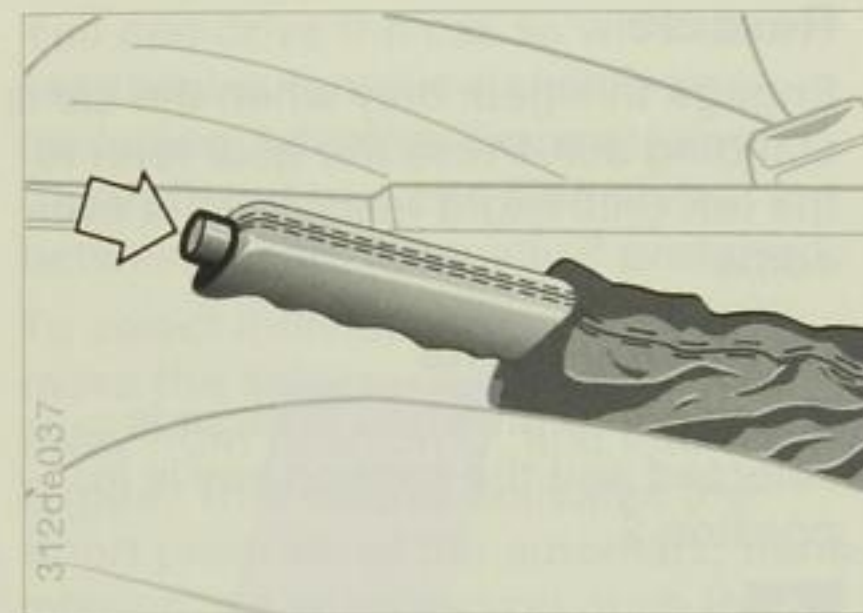
**Applying**

The lever has a ratchet which holds it on automatically. The telltale light on the instrument panel comes on.

Releasing

Pull the lever up slightly, press the knob in and lower the lever.

The handbrake acts on the rear wheels. If it has to be applied while the car is moving, do not pull the lever up too hard, or else the rear wheels could be overbraked and the tail of the car could slide.

To avoid corrosion, apply the handbrake lightly from time to time when coasting to a standstill, for instance at a traffic signal, provided that it is safe to do so.



The brake lights do not come on when the handbrake is applied. ◀

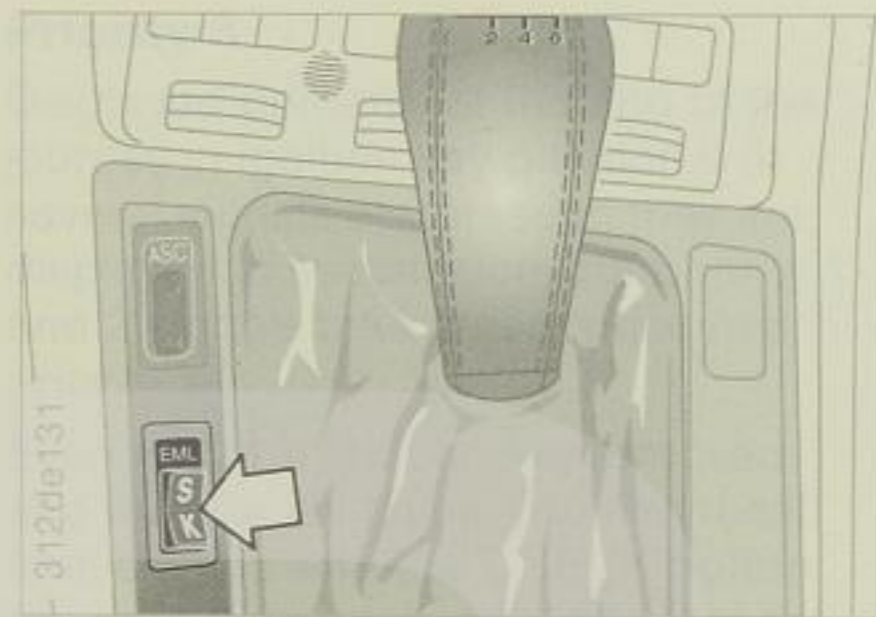

BMW 850CSi

Electronic engine output control (EML) has two programs for operation of the accelerator pedal: "Comfort" and "Sport".

Switch positions

K – Comfort setting, for driving at a moderate engine power or on a wet or slippery road

S – Sport setting

The switch is illuminated in ignition key position 2. Only the S setting is shown on the instrument panel.

If the EML warning light on the instrument panel indicates a malfunction, take the car to BMW Service.

Manual gearbox

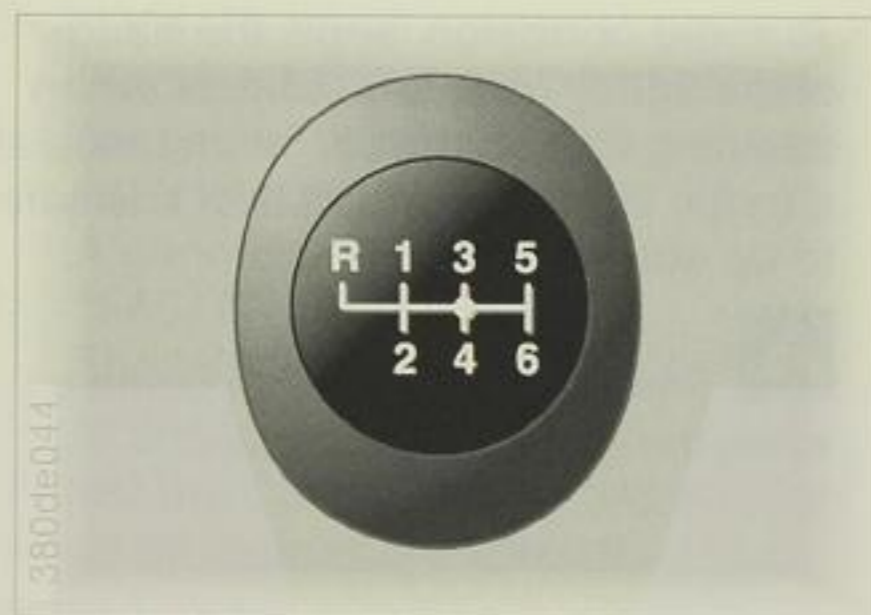

The normal rest position for the gear lever (marked by a dot) is in the 3rd/4th gear plane of the gate.

When the lever is moved from a forward or reverse gear into neutral, it is automatically spring-loaded to return to this plane of the gate.

! When selecting 5th or 6th gear, the lever must be pressed firmly to the right, to ensure that 3rd or 4th gear is not selected accidentally. ◀

Reverse

Engage this gear only when the car is standing still. Press the gear lever to the left until slight resistance is overcome.

Reversing lights

These come on when reverse is selected and the ignition key is in position 2.

! Never try to prevent the car from rolling back on an uphill gradient by slipping the clutch; always apply the handbrake. A clutch that is allowed to slip will wear rapidly. ◀

Automatic transmission with STEPTRONIC

You can drive the car as with a conventional automatic transmission (including Adaptive Transmission Control), but you can also shift between gears manually if preferred.

To select individual gears manually, move the selector lever to the left, away from position D, and into the M/S gate. This initially activates the Sport program of the automatic transmission. As soon as you push the selector lever briefly in direction "+" or "-", the Steptronic shifts the transmission up or down a gear.

To return to the automatic mode, push the selector lever to the left, into position D.

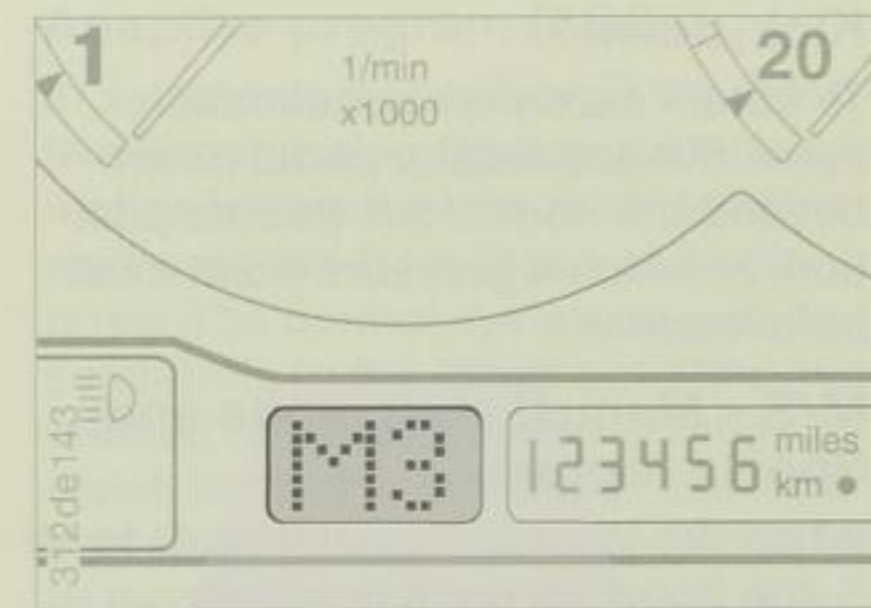

Selector lever positions

	P	R	N	D	M/S
Adaptive program				D	
Sport program				S	
Manual mode				M	
- shifting up				+	
- shifting down				-	

The display (see picture) shows selector lever positions P R N D or, in the Sport program, SD. When in the manual shift mode, the gears are shown as M1...M5.

For notes on operation in the M/S gate, see Page 70, and for details of the Adaptive program see Page 71.

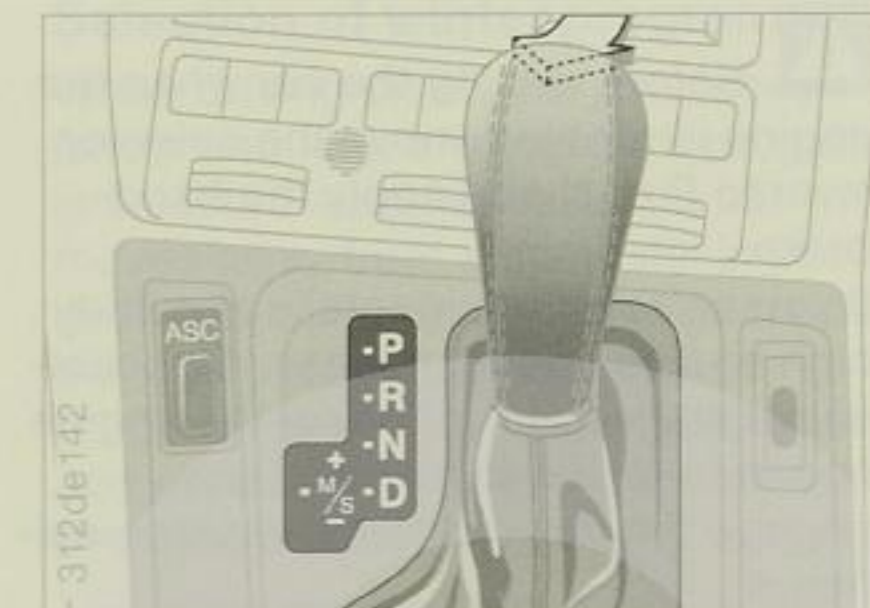

Moving the selector lever

A lock prevents the lever from being moved to positions R and P accidentally; the lock is released by pressing the button on the front of the selector lever handle (arrow).

The engine can only be started in selector lever positions P or N.

Before selecting any drive position, apply the foot brake, since the car will always tend to creep with a gear selected, even at idle speed.

When a drive ratio (forward or reverse) is engaged, wait until the transmission is felt to engage before releasing the brake and accelerating.



Before leaving the car when the engine is running, move the selector lever to P or N and apply the hand-brake.

If you select N accidentally at a fairly high engine speed, release the accelerator immediately. Wait for the engine speed to return to an idle, then engage the desired transmission position. ◀

P – Parking

Engage this gear only when the car is standing still. The driven wheels are locked.

R – Reverse

Engage this gear only when the car is standing still.

N – Neutral

Select only if the journey is interrupted for a fairly long time. When the car is being driven, only select neutral if a skid occurs.

D – Drive (automatic selection of forward gears)

Use this position for all normal driving. All forward gears are available and the AGS is operational.

Kick-down

To obtain maximum acceleration, press the accelerator pedal down beyond the normal full-throttle position, at which a pressure point must be overcome.

M/S – Manual shift mode and Sport program

When the lever is moved from D to M/S, the Sport program is initially selected (S appears in the gear display).

In position S, the AGS uses only the gearshift program with the most pronounced sports characteristic. The transmission shifts up as far as 4th gear.

The Sport program is recommended if you wish to make the most of the car's performance regardless of your current driving style.

If you now push the selector lever briefly forwards in the "+" direction, the transmission shifts up; if it is pulled back in the "-" direction, it shifts down. The first time the lever is pushed in either direction, the transmission switches to the manual mode. The gear display shows M1 ... M5.

Unacceptable up- or down-shifts are disregarded by the Steptronic, for instance no down-shift takes place if it would lead to the engine overspeeding. The selected gear is displayed briefly on the instrument panel. If gears are changed several times in rapid succession, the last (impermissible) gearshift is shown briefly in the transmission display, then the current gear displayed again.



Note that when driving in the manual shift mode, adequate acceleration may not be available – for example when overtaking – in 4th or 5th gear, and a manual down-shift should therefore be made or the kick-down used. ◀

To select P, R and N from the M gate plane, the lever must first be moved back to D.

Steptronic "thinks along with you" in the following situations:

- ▷ To avoid excessive engine speeds, it shifts up to the next-higher gear automatically just before the governed maximum engine speed is reached.
- ▷ At low speeds, it shifts down automatically without any action on the driver's part.

- ▷ The kick-down facility selects the lowest gear which can still be used without risk of the engine overspeeding.
- ▷ The car may move away from a standstill in 2nd or 3rd gear if the situation demands, for instance in winter driving conditions.

Shift electronics



If the warning light comes on or the "TRANS FAIL-SAFE PROG" appears on the Check Control, there is a malfunction in the shift electronics or in the automatic transmission.

All selector lever positions can still be selected, but in any forward gear position, only 4th and 5th gears are actually available.

Avoid severe loads and take the car to the nearest BMW Service point.



Never work inside the engine compartment if a gear has been selected at the automatic transmission. Never leave children unattended in the car. ◀

For tow-starting, towing away and starting with a flat battery, see Pages 108, 109, 110.

Adaptive program (AGS)

In selector lever position D the Adaptive Transmission Control system automatically chooses the most suitable shift program from those at its disposal. The control system responds sensitively to the driver's wishes (e.g. relaxed or more dynamic driving style), to road influences (e.g. slippery surfaces or steep uphill gradients) and to the current driving situation (e.g. twisting road, descending steep hill).

Special functions

In selector lever position D the Adaptive Transmission Control system influences the shift points by means of various special functions.

This has the effect of suppressing certain shifts that would normally have occurred, and may cause others to take place in certain circumstances although the driver would not have expected them.

Selection of winter program

When driving on slippery surfaces (snow and ice), a winter shift program is selected automatically. The car moves away from a standstill in 2nd gear and shifts up to higher gears as early as practicable. This makes progress over slippery surfaces easier and enhances the car's traction and dynamic stability.

The transmission moves out of the Winter program when the AGS detects a higher-grip road surface or if DSC is switched off.

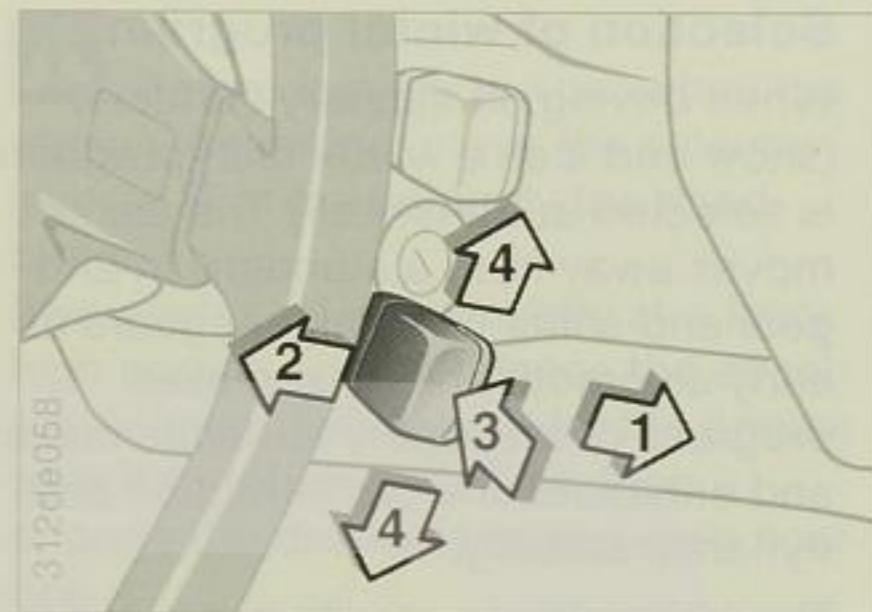

Any desired road speed above approx. 40km/h can be memorised and maintained automatically.

The memorised speed value is lost when the engine is switched off.

1 Acceleration

Moving the lever briefly:

The car's actual speed is maintained and memorised. Each time the lever is moved briefly to this position again, road speed is increased by app. 1 km/h.

Holding the lever in this position:

The car accelerates without the accelerator pedal being touched. When the switch is released, the speed then reached is maintained and memorised.

2 Deceleration

Holding the lever in this position:

The car decelerates by automatic restriction of the throttle, provided it was previously travelling at a controlled speed. When the switch is released, the speed then reached is maintained and memorised.

Moving the lever briefly:

Each time the lever is moved briefly, the road speed is reduced by app. 1 km/h if it was previously travelling at a set speed.

3 Recall

Moving the lever briefly:

The speed last memorised is recalled and maintained once it has been reached again.

4 Off

Moving the lever briefly:

the cruise control facility is switched off immediately.

The cruise control is also switched off automatically:

- ▷ If the car exceeds the selected speed by app. 16km/h (10 mile/h)
- ▷ If the car's road speed falls more than 8km/h (5 mile/h) below the selected speed
- ▷ If a high rate of deceleration occurs (above 1.5m/s²), for example on a steep hill, when braking and declutching or if the automatic transmission selector lever is moved from D to N.



Do not use the cruise control on twisting roads, if traffic is heavy or in any other situation which makes it too difficult to maintain a constant speed, nor when the road could be slippery (snow, rain or ice) or on a loose surface (stone chippings or sand). In such situations, the car's behaviour will not be sufficiently flexible to take road and traffic conditions into account. ◀

EDC*

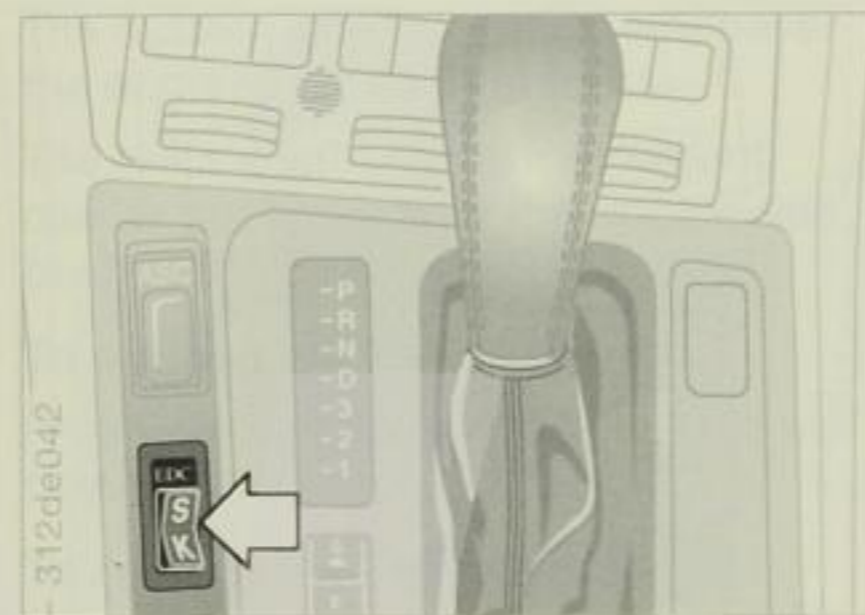

The electronic damping control (EDC) automatically ensures that the desired degree of suspension damping is provided, and thus enhances both safety and ride comfort.

The Comfort program is selected each time the engine is started.

Switch positions:

K – Comfort Program

S – Sport program

The driver can switch from one program to the other at any time.

In ignition key position 2, the selected switch position is illuminated.

ASC+T

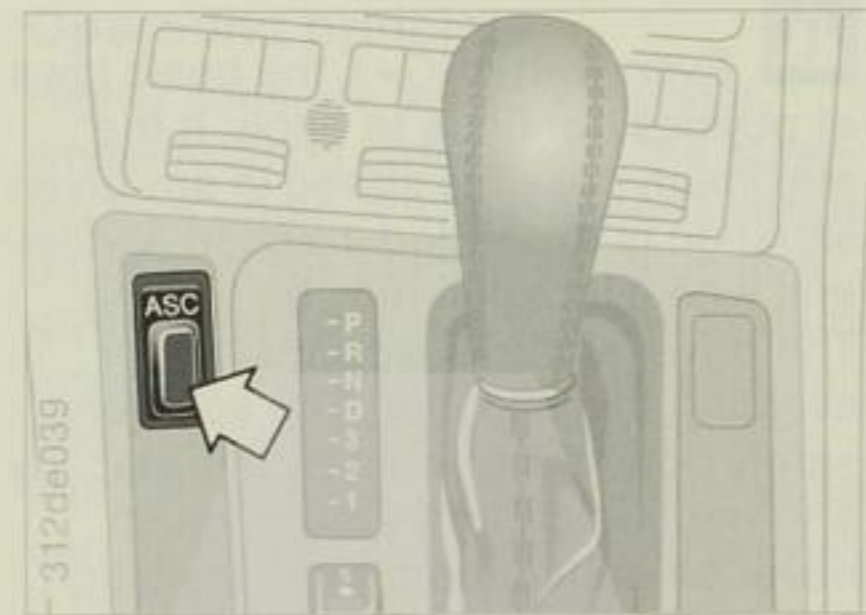

Automatic Stability Control plus Traction (ASC+T) - BMW 850 CSi

This system improves driving stability, particularly when accelerating and cornering.

The system is in operation whenever the engine has been started.

The telltale light in the instrument cluster goes out after the engine has been started.

To switch off the system:

Press the button; the telltale light will come on.

To switch the system on again:

Press the button again; the telltale light will go out.

If the telltale light flashes:

The system is active, that is to say it is compensating for fluctuations in traction caused by road conditions.

If the telltale light does not go out after the engine has been started or comes on during the journey: the system is defective, but the car itself is fully operational with the exception of the ASC+T stability control function. Take the car to BMW Service to have the fault repaired.

Operating principle

High-precision sensors monitor wheel rotating speeds. If differences are detected, the system interprets them as a sign that wheelspin is about to set in, and reduces the power input from the engine accordingly. If necessary, the rear wheel brakes are also applied momentarily to suppress wheelspin.

Although the action of this system may seem to be restricting available engine power and therefore be difficult for the driver to accept, it should be remembered that as much traction as can be achieved, and therefore optimum acceleration, are always available for the prevailing road, driving and climatic conditions, without exceeding the limits of dynamic stability.



Even with ASC+T, the basic laws of physics continue to apply. If the maximum possible speed in any given situation is exceeded, traction and lateral wheel location may be lacking. The driver alone is responsible for avoiding this situation. The additional safety potential offered by this stability and traction control system must never be understood as an invitation to take additional risks. ◀

The system may react adversely if tyres of different makes and types are used on the same car. You should therefore try to ensure that all the car's tyres are identical in make, type and tread pattern.

By switching off ASC+T it is possible to revert to the conventional driveline (without electronic control). It may be desirable, for instance, to switch off the system to ensure maximum potential traction

- ▷ If the car has to be rocked out of a hollow on a soft surface, or started in deep snow or on a loose surface.
- ▷ if snow chains are fitted.

DSC

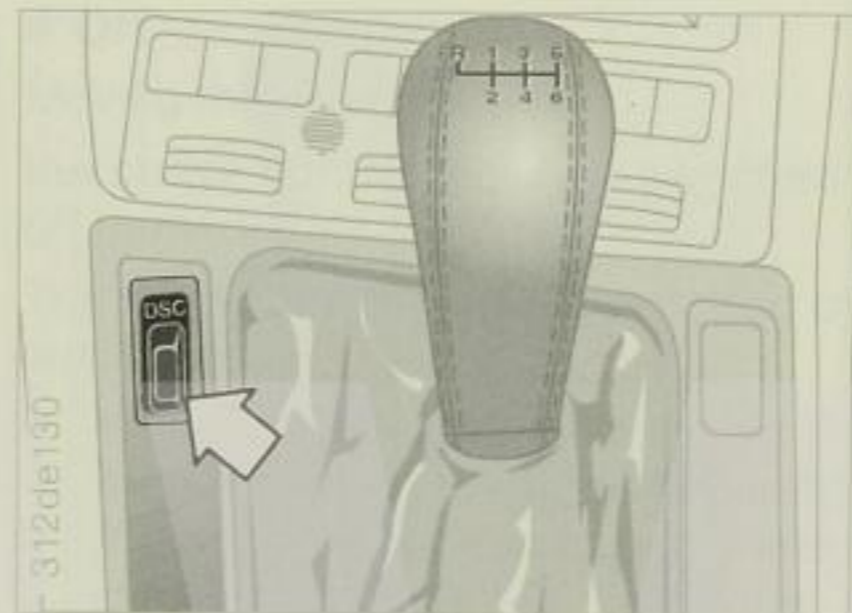

BMW 840Ci, 850Ci

Dynamic Stability Control (DSC) is an extended form of Automatic Stability Control plus Traction (ASC+T).

It improves dynamic stability, particularly where lateral forces are encountered (e. g. cornering) and when accelerating.

It identifies and counteracts unstable driving situations and prevents the driven wheels from spinning in poor-grip or otherwise unfavourable conditions (slippery surfaces, bends).

DSC

The system is in operation whenever the engine has been started.

The telltale light in the instrument cluster goes out after the engine has been started.

To switch off the system:

Press the button; the telltale light will come on.

To re-activate the system:

Press the button again; the telltale light will go out.

Telltale light

If the telltale light flashes:

The system is active, that is to say it is compensating for fluctuations in traction caused by road conditions.

If the telltale light does not go out after the engine has been started or comes on during the journey:

The system is defective, but the car can still be driven normally with DSC out of action. Take the car to BMW Service to have the fault repaired.

Operating principle

Highly-sensitive sensors monitor wheel rotating speeds and the steering lock angle. If wheel speeds vary or differ from the calculated value at a given steering lock angle, the system registers the likelihood of wheelspin and reduces engine output accordingly; if necessary, either driven wheel can be braked momentarily to prevent it from spinning.

Although the action of this system may seem to be restricting available engine power and therefore be difficult for the driver to accept, it should be remembered that as much traction as can be achieved, and therefore optimum acceleration, are always available for the prevailing road, driving and climatic conditions, without exceeding the limits of dynamic stability.

When the system is functioning and the brakes are being applied, a certain amount of noise is generated.



Even with DSC, the basic laws of physics continue to apply. If the maximum possible speed in any given situation is exceeded, traction and lateral wheel location may be lacking. The driver alone is responsible for avoiding this situation. The additional safety potential offered by this system must never be understood as an invitation to take additional risks. ◀

The system reacts sensitively if tyres of different makes and types are used on the same car. You should therefore ensure that all the car's tyres are identical in make, type and tread pattern.

By switching off DSC it is possible to revert to the conventional driveline (without electronic control). It may be desirable to switch off the system to ensure maximum potential traction

- 1 If the car has to be rocked out of a hollow or started in deep snow or on a loose surface.
- 2 if snow chains are fitted.

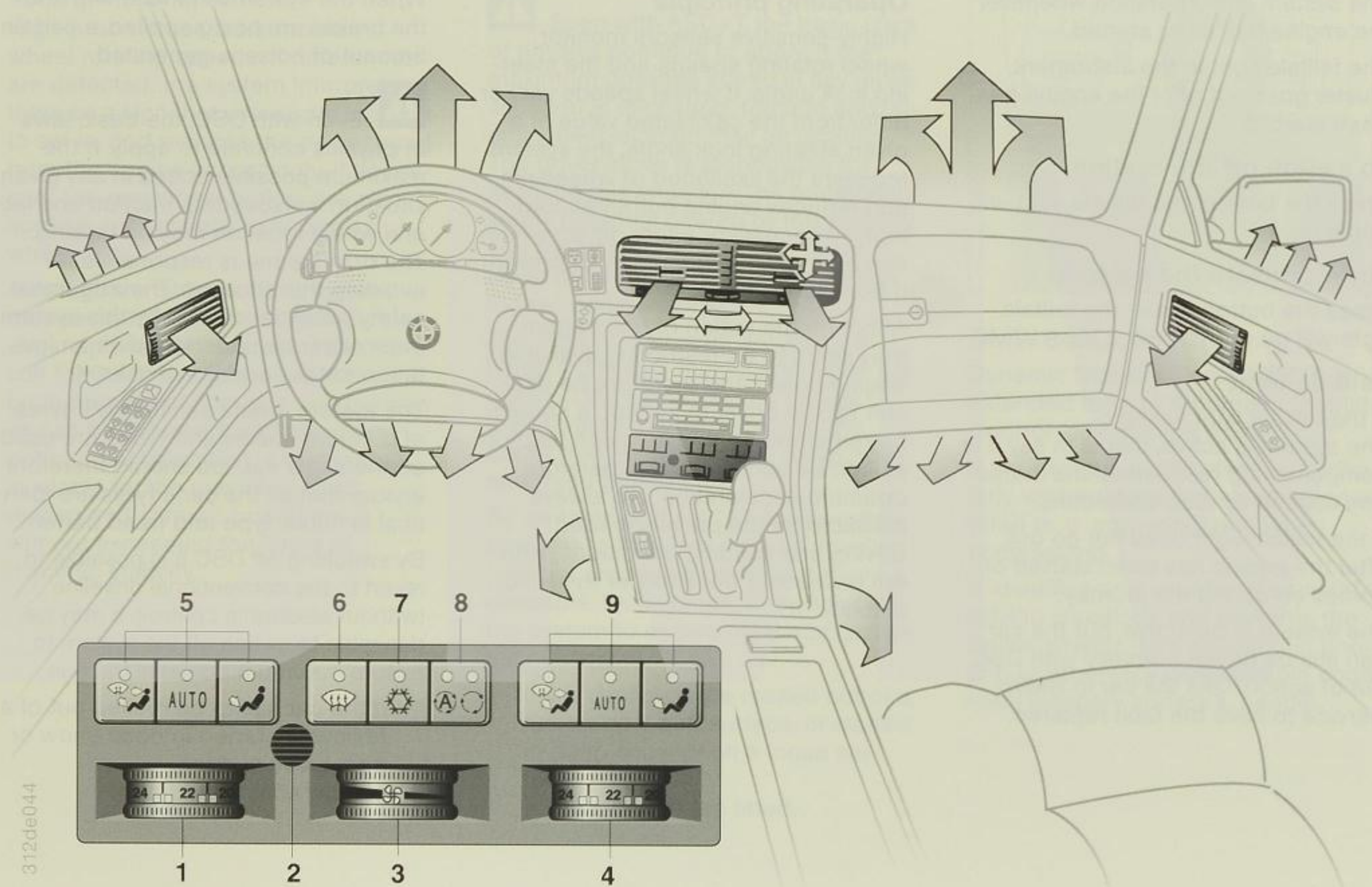

312de044

- 1 Temperature selector for left side of car
- 2 Avoid blocking the air entry grille for the interior temperature sensor
- 3 On/off switch and airflow volume selector
- 4 Temperature selector for right side of car
- 5 Program buttons for air distribution on left side of car
- 6 Pushbutton for maximum windscreen and side window demisting system
- 7 Pushbutton for air conditioning system
- 8 Pushbutton for Automatic Recirculated Air Control (AUC) or for recirculated air operation
- 9 Program buttons for air distribution on right side of car

When a button is pressed, the corresponding LED lights up if the system was switched on at airflow volume selector wheel (3).

Temperature selectors for left and right sides of car



The temperature control is switched on and off at the rotary knob on the driver's side:

Left-hand limit position: no heating effect, maximum cooling output, temperature control off.

As the control is turned to the right, away from the detent position: temperature control cuts in.

Right-hand limit position (detent): maximum heating output, temperature control off (also emergency position if a fault develops in the electronic temperature control system).

The scales are merely intended as a guide to the interior temperature. The selected setting is reached as quickly as possible and does not normally need to be adjusted subsequently.

Alter settings by only small amounts at a time, to avoid undesirable temperature fluctuations.

On/off switch and airflow volume selector



Position 0: system is switched off, air intake closed.

Turned to the right as far as first detent: system switched on, minimum airflow.

Turned farther to the right: airflow increases.

Right-hand limit position (detent): maximum airflow volume (also emergency position if a fault develops in the electronic blower control system)

Program buttons for air distribution to left and right sides of car



Automatic air distribution

 With only a few exceptions, this program can be used in all normal driving conditions.

Depending on actual temperatures, the air inlets are opened and closed automatically.

To ensure freedom from fatigue, the system works according to the warm feet - cool heat principle.

However, the air emerging from the facia grilles can be varied separately in temperature; see next page.

To ensure that this program can operate effectively, some of the outlet grilles on the facia and the doors must be open and the airflow volume selector should be turned past the first detent.

Air distribution through all grilles and outlets - no automatic control



This program is recommended in warm weather, for instance, if extra ventilation or cooling of the footwell areas is needed.



If the windscreen mists over on the outside when atmospheric humidity is very high, press the AUTO button or the airflow button for the footwell outlets only. No cooled air will then be directed onto the windscreen. ◀



Press this button to increase the airflow out of the ventilation grilles if the windscreen and side windows mist over during a journey and it would be undesirable to press button 6 (maximum windscreen and side window demisting). ◀

Airflow to the footwell outlets only



The demisting outlets are also slightly opened.

This program is recommended in cool weather, for example, when airflow from the grilles is not wanted, or to heat up the footwells rapidly.



In all programs, air emerges from the demisting outlets only at first after a cold engine has been started, until the heater matrix has reached app. 30°C. ◀

Pushbutton for maximum demisting and drying of windscreen and side windows



The windscreen and the side windows can be cleared and dried rapidly with this program. The previously selected program is not lost.

For maximum effect, the engine must be at regular operating temperature.

Pressing this button again (the LED goes out) automatically restores the system's previous settings.

The windows mist or fog over as a result of moisture and condensate caused severe differences in temperature or a high level of humidity. The only remedy is to dry the glass with plenty of warm air.



The first time this button is pressed after starting the engine, the rear window heating is also switched on. ◀

Air conditioning

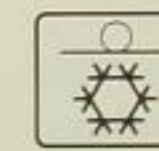

The air is cooled and dried when the air conditioning is switched on, then re-heated according to the chosen temperature. Depending on weather conditions, the windscreen may fog over momentarily when the engine is started.

At outside temperatures below about 5°C, switch the air conditioning off to prevent the windows from fogging. The windows may mist over if the system is switched on and off too often. If air humidity is very high, it is best to switch the air conditioning on in good time (before moisture condensate can reach the evaporator) and dry the air, so that the windows do not fog over. Take care not to direct cooled air on to the windscreen, as it could mist or freeze over on the outside.

At the maximum cooling setting, the system switches over automatically to recirculated-air operation and the defroster outlets are closed.

We recommend leaving the air conditioning system switched on permanently in the summer.

Important notes on air conditioning system

It is common for the windows to mist over temporarily after the engine has been started and with the air conditioning system on.

When the air conditioning system is running, moisture and condensate produced by the evaporator is discharged under the car and may leave visible trails on the ground.

If the air conditioning system develops any faults, for instance if no cool air is delivered even when the controls are set accordingly, switch it off and consult BMW Service without delay.

Recirculated air mode

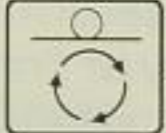
 This is recommended if the outside air is dusty or smells objectionable. The air already inside the car then passes through the system repeatedly.

Although the air conditioning is switched on automatically at the same time to improve the quality of the air (and dry it), you should not drive too long with the system in the recirculated-air mode.

 If the windows fog over when the recirculated-air mode is in use, switch to fresh-air operation and run the air conditioning by pressing button 7. ◀

Pushbutton for Automatic Recirculated Air Control (AUC)

 Three functions are obtained in succession by pressing this repeatedly, and confirmed by LEDs.

Fresh-air operation: LEDs off.

Normal operation with fresh air from outside the car.

AUC operation: left LED is on.

The system identifies peak pollutant loads in the outside air and prevents them from reaching the car's interior.

A sensor measures the level of pollutants in the outside air. If the values increase, the system switches over automatically to recirculated-air operation.

Recirculated-air operation: the right LED comes on.

 If the windows mist over on the inside when AUC or the recirculated-air mode are in use, switch to fresh-air operation (LEDs go out), start the air conditioning with pushbutton 7 and if necessary increase the airflow volume. Noises heard after the engine has been switched off are caused by the actuating motors returning the ventilation flaps to their rest positions. ◀

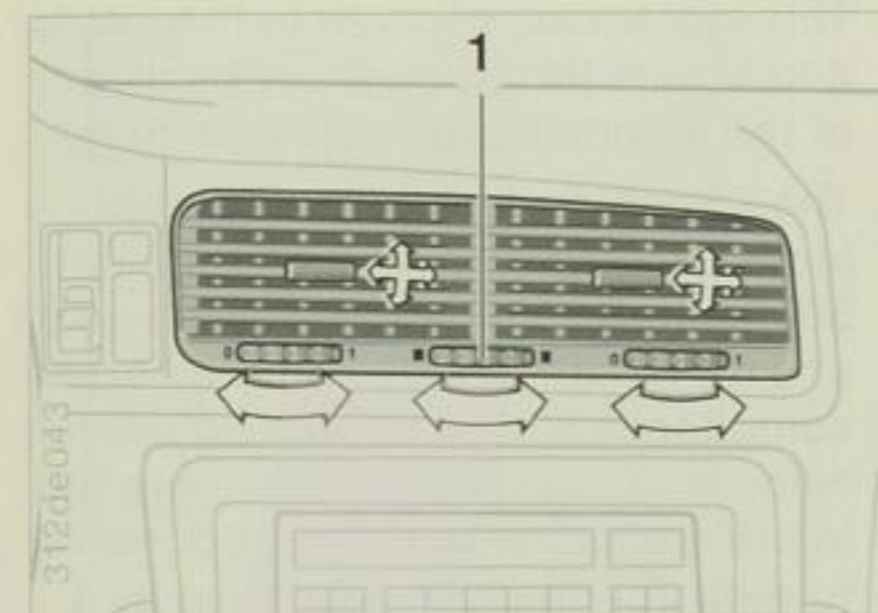

Warm feet and a cool head: stratified interior air temperature for fatigue-free driving

The air emerging from the fascia and door grilles can be varied in temperature (except when maximum cooling is required):

Knurled wheel 1 turn to right – warmer
turn to left – cooler.

Micro-filter

Fresh air is drawn in through a micro-filter. This filters out up to 100% of all pollen and up to 60% of dust particles in the air.

Change the filter at the car's regular servicing intervals. If airflow is noticeably lower than usual, this may indicate that the filter should be renewed earlier.

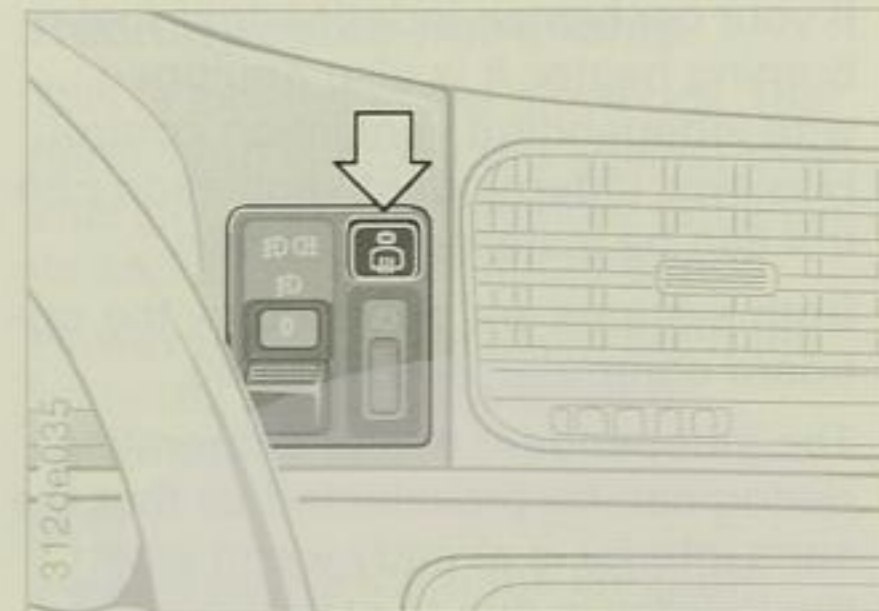

Press the button: When the telltale light is on, the heated rear window is operating at full heat output (rapid demisting).

When the telltale light goes out, the heated rear window has switched over automatically to a low rating in order to save power. It cuts out completely after about 20 minutes unless switched off previously.

If necessary, press the button again: This will start a new rapid demisting cycle.

To switch off: If the telltale light is on, press the button.

Whenever the engine is restarted, the heated rear window has to be switched on again if still required.

If your car has an independent fuel-burning heater, it is also equipped with independent ventilation control. However, independent ventilation control can be installed on its own.

Both systems are operated by the on-board computer; see Page 60.

The independent heater's operating period can be preselected so that the car's interior is already warm when the journey is due to start. Snow and ice are also easier to remove from the windows.

The independent heater runs for 30 minutes. Since its current consumption is high, it should not be run twice in succession unless there has in the meantime been an opportunity to recharge the car's batteries by a period of driving reasonable speeds.

The independent heater can also be switched on and off directly.

The independent heater can be run at outside temperatures below 16°C, but not while the car is being driven.

The heated air is supplied automatically to the car's defrosting and footwell outlets; the heater runs at maximum output in all cases.

In ignition key position 1 you can vary the interior temperature (at the temperature selectors) and the air distribution (by means of the pushbuttons). After it has been switched off (LED off) the independent heater continues to run for a short period.

If the independent heater does not start after a maximum of two attempts, or switches itself off automatically, consult BMW Service.

▶ Even during the warm season of the year the independent heater should be run briefly about once a month.

To do this if the temperature is above 16°C:

- ▶ Press the TEMP and TIMER buttons on the on-board computer at the same time: the INV (inverted) inscription will appear.
- ▶ Switch the independent heater on directly and switch off again after about 5 minutes. ◀

⚠ Never operate the independent heater in an enclosed space. Always switch off the independent heater before refuelling the car. ◀

Independent ventilation

This system supplies air to the interior and lowers its temperature by means of the automatic air conditioning fan.

The switch-on time can be preselected; the ventilation then runs for 30 minutes. It can also be switched on and off directly. Since its current consumption is high, it should not be run twice in succession unless there has in the meantime been an opportunity to recharge the car's batteries by a period of driving reasonable speeds.

Independent ventilation control is available at outside temperatures above 16°C, but not when the car is being driven.

Air is driven to the grilles in the fascia and doors. These grilles must therefore be opened before the independent ventilation control is switched on or preselected.

Roller sun blind

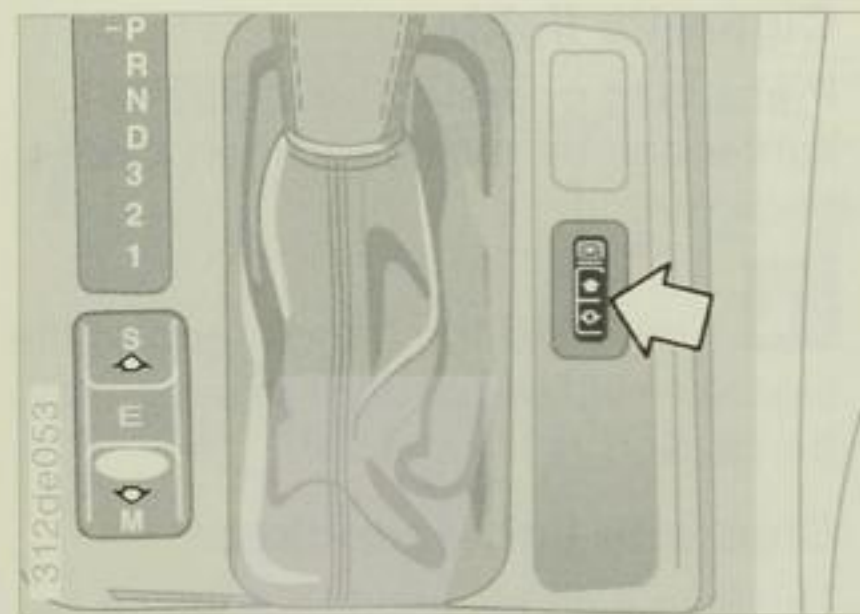

Electrically operated roller sun blind for rear window

To operate, press the rocker switch briefly; the ignition key must be in position 2.

Glove box

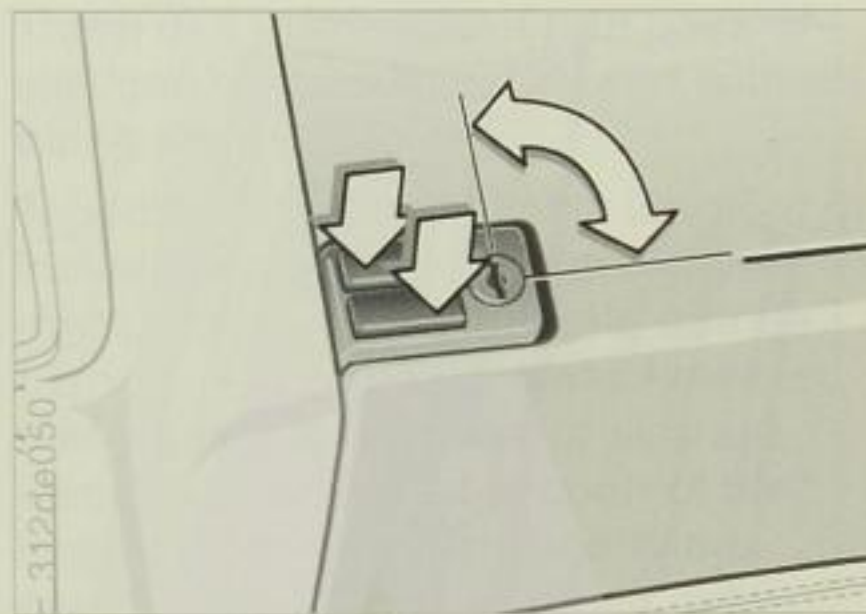

To open: press the appropriate catch.

The light inside will come on automatically.

To fasten: shut the lid.

To lock: this is only possible with a master key. When the glove box is locked, the luggage compartment is also locked.

⚠ To avoid risk of injury, the glove box should be kept closed when not in use. ◀

Rechargeable hand lamp

This is located in the glove box. The hand lamp is protected against overcharging and can therefore remain in its socket for an unlimited period.

However, it must be taken out if the batteries are disconnected or removed.

⚠ Always switch the lamp off before inserting it into its socket. ◀

Cup holders

There are 2 fold-out holders for cups or drink cans on the inside of the glove box lid.

Other storage compartments

In the compartment on the centre console and in the pockets on the doors and front edge of the front seats.

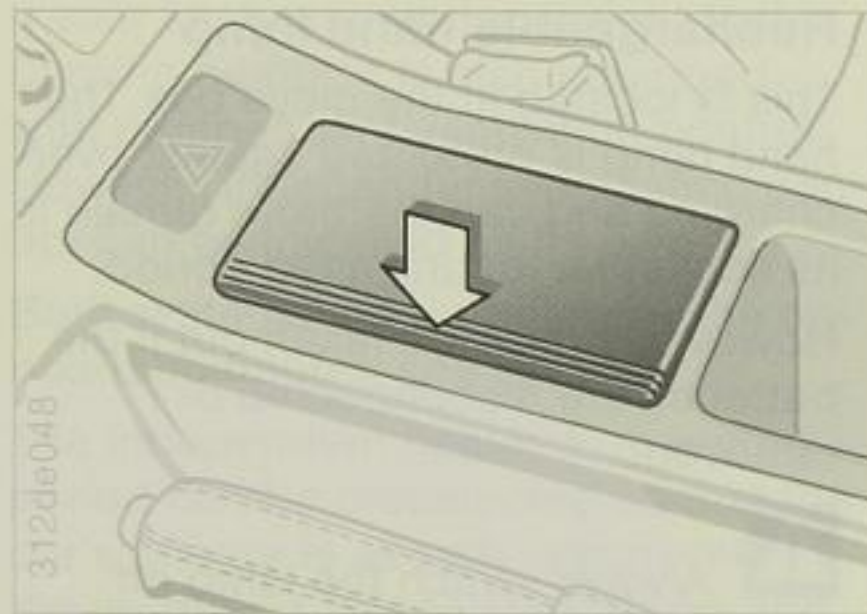

To open:
Press down to the left of the lid (arrow).

To extinguish a cigarette, knock off the ash and insert a short distance only into the funnel-shaped hole.

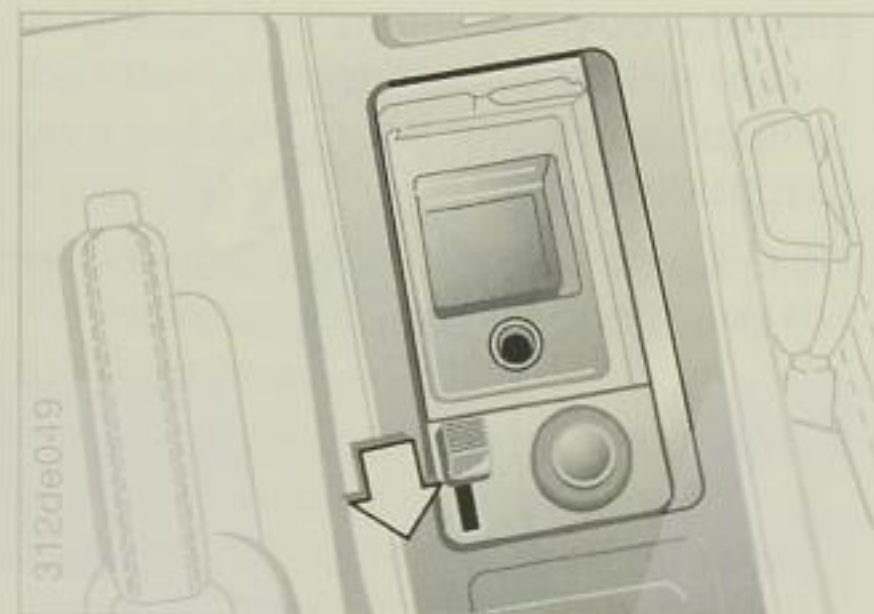

To empty:
With the ashtray open, move the lever in the direction of the arrow. The ashtray can be removed.

Cigarette lighter

Press in to operate. The cigarette lighter can be removed when it pops back out.

! Only hold the handle end of the cigarette lighter, or burn injuries may be caused. ◀

Cigarette lighter socket

This can also be used to power a hand lamp, a car vacuum cleaner or similar items rated at not more than 12Volts, app. 200Watts. Make sure that the socket is not damaged by attempting to insert plugs of the wrong pattern.

! The cigarette lighter remains operational when the ignition key has been removed. For this reason, do not leave children in the car unattended. ◀

Rear seat backs*

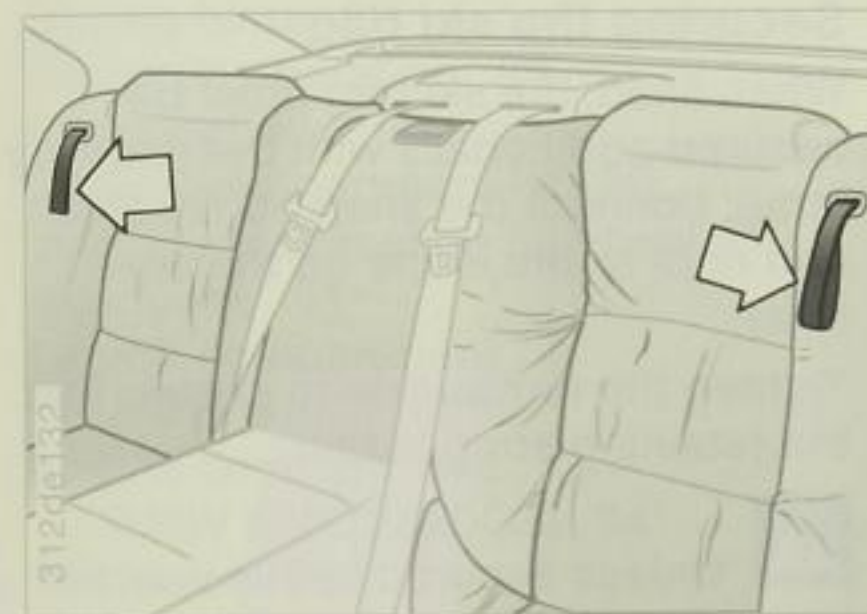

Folding rear seat backs*

So that items of luggage of moderate size can be carried, the left and right seat backs can be folded forwards after pulling the strap (arrow).

When raising the seat back, make sure that it is heard to engage in position.

Ski bag

Three or a maximum of four pairs of skis can be carried safely and without being exposed to dirt.

Together with the available length inside the car's luggage compartment, skis up to 2.10m long can be carried in the ski bag. Note, however, that when several pairs of skis are inserted the tapered section of the bag reduces the overall carrying capacity, so that for example only 2 pairs of 2.10 m long skis can be carried.

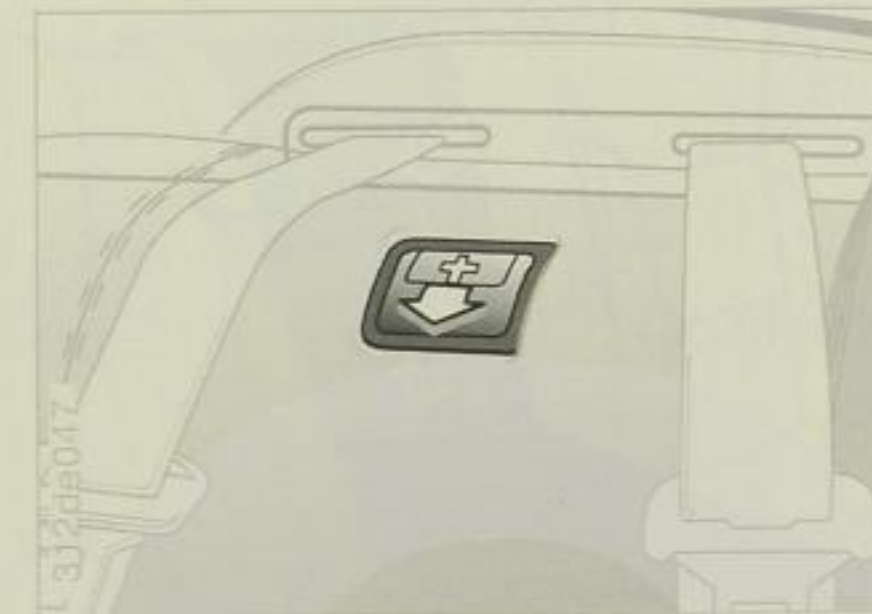

Inserting items into ski bag

Pull the release lever (arrow). Swing the centre section of the seat forwards, complete with its integral first-aid box, and lift it off.

▶ When installing the centre section again, insert it into the lower guides first and swing it back until it is heard to engage in position. ◀

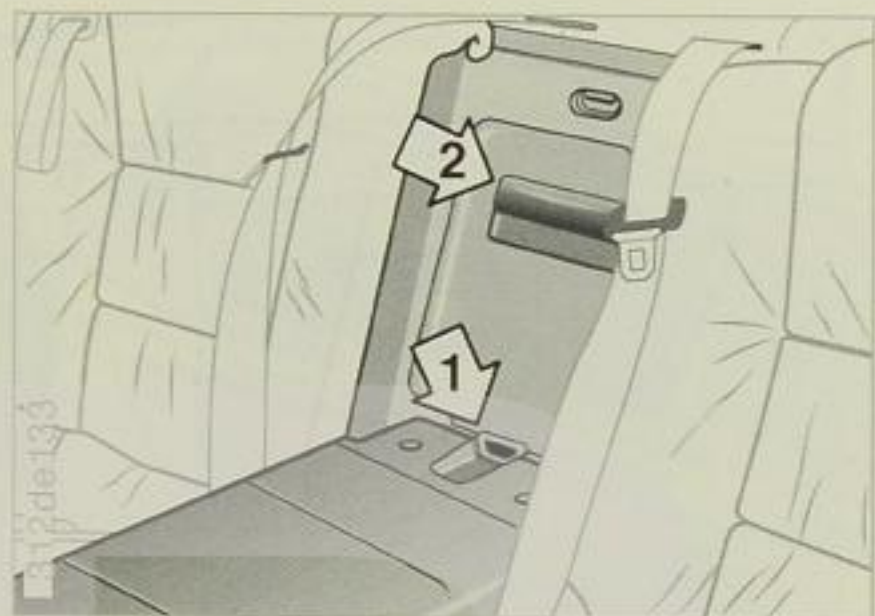

Press the release catch (arrow 1): this will release the loading flap in the luggage compartment.

Open the cover inside the car (arrow 2) and swing it down.

Lay out the ski bag between the front seats. It has a zip fastener for better access to the items inside, and for use when the bag needs to be dried out.

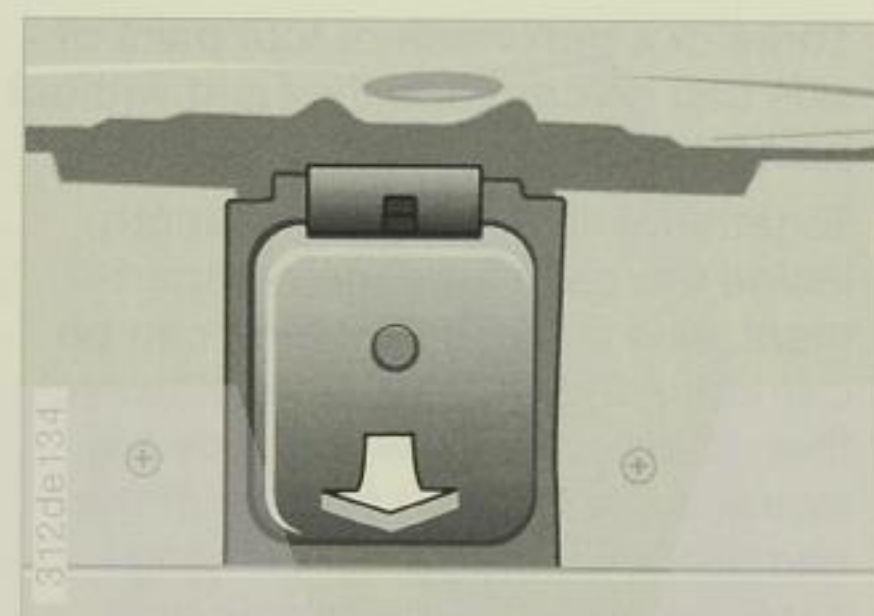

From the luggage compartment side, attach the cover flap to the underside of the rear-window shelf with the magnetic holder provided.

Make sure that the skis are clean before they are inserted into the ski bag, and that any sharp edges on them or their bindings do not damage or pierce it.

If the ski bag is not to be used for a considerable time, it must be dry before it is rolled up and stowed away.

Securing the ski bag

When filled, the ski bag must be secured additionally with the retaining strap; connect the snap hooks at left and right to the loops on the seat base.

Tighten the turnbuckle to ensure that the retaining strap is taut.



Unless secured in this way, the ski bag could interfere with the driver's control over the car or cause even injury in the event of an accident. Make sure that the ski bag does not obstruct the driver's movements. ◀

Driving hints 88
 Car radio operation 89
 Car telephone 89
 Engine compartment lid 90
 Vehicle identification number 91
 Type plate 91
 Engine compartment
 - BMW 840Ci 92
 Engine compartment
 - BMW 850Ci/850CSi 94
 Engine oil 96
 Hydraulics 98
 Hydraulics and ARK 98
 Brake fluid 99
 Coolant 100
 Washer fluid for the cleaning systems 101
 Washer jets 102
 Power steering 103
 Brakes 103
 Batteries 104
 Fuses 106
 Toolkit 107
 Warning triangle 107
 Fire extinguisher 107
 First aid box 108
 Tow-starting, towing away 108
 Tow-starting 109
 Towing away 109
 Starting with a flat battery 110
 Changing a wheel 111
 Thieftproof wheel studs 114

Fuel filler flap 114
 Luggage compartment 115
 Sliding/tilt roof 115
 Headlights 115
 Renewing wiper blades 116
 Bulb-changing 117
 Winter operation 122
 Towing a trailer 123
 Roof rack 126
 Right/left rule of the road 126
 Licensing car for use abroad 127
 ABS 127
 Active Rear Axle Kinematics (ARK) 129
 Disc brakes 130
 Tyre pressure 131
 Tread depth 131
 New tyres 132
 Interchanging wheels and tyres 132
 The correct choice 133
 Winter tyres 134
 Approved wheels and tyres 135
 Technical modifications 136

Important facts in brief

Controls

Operating hints

Care and maintenance

Technical data

Index



Do not rest your foot on the brake pedal while the car is in motion. Even slight continuous pressure on the brake pedal could cause overheating, brake pad wear or even brake system failure.

Aquaplaning:

Reduce speed when driving on wet or slushy roads, since a wedge of water could otherwise build up between the tyres and road. This situation, known as aquaplaning, means that the tyre can actually lose contact completely with the road surface, so that the car can neither be steered nor braked properly. You should therefore always reduce speed on a wet road.

Rear-window shelf:

Never place hard or heavy objects on the rear window shelf; they could be dislodged when the car is braked heavily and endanger the occupants.

Coat hooks:

When hanging clothing from the hooks, do not obstruct the driver's view. Do not hang heavy objects from them, to avoid the risk of personal injury if the car is braked suddenly. ◀

Cars with catalytic converter

The catalytic converter reduces pollutant emissions in the exhaust.

Cars equipped in this way must always be run on unleaded fuel only.

Even a very small amount of lead will permanently damage the oxygen sensor and catalytic converter.

To ensure that the engine always operates correctly and reliably, and to avoid damaging it, the following instructions should be complied with:

- ▷ Do not run the fuel tank dry.
- ▷ Switch off the engine at once if misfiring occurs.
- ▷ Never tow-start the car unless the engine is cold, or else unburned fuel may reach the catalytic converter. It is always preferable to use jumper leads from another car or a separate battery to start the car.
- ▷ Avoid any other situations in which unburned or only partially burned fuel could pass through the engine, for example: frequent operation of the starter for very short periods or repeated attempts to start if the engine does not fire. (However, switching off an engine which is running normally and restarting it again shortly

afterwards is perfectly acceptable.) Running the engine with a spark plug lead detached.

- ▷ Always have the specified maintenance work carried out at the stated intervals.

If unburned fuel reaches the catalytic converter as a result of misfiring or fuel-air mixture preparation malfunctions, overheating and damage may result.



High temperatures occur on all vehicles equipped with a catalytic converter. Make sure that no easily combustible material (for example hay, leaves, grass etc.) comes into contact with the hot exhaust system when the car is being driven, is idling or is parked. If this material were to ignite and cause a fire, very severe injuries or damage could result.

Do not remove the heat shields from the exhaust system, or apply under-seal to them. ◀

Car radio operation*

For adjustments to your car radio and correct operation of its controls, please refer to the accompanying operation manual.

The reception and reproduction quality of any mobile radio installation depends on the range of the transmitter you wish to pick up and the alignment of the aerial.

Interference from high-tension overhead wires, but also buildings and natural obstructions, may cause noise and signal deterioration which cannot be avoided even if the vehicle's own interference suppression systems are in good working order.

Climatic influences such as sun spots, fog, rain or falling snow also influence radio reception.

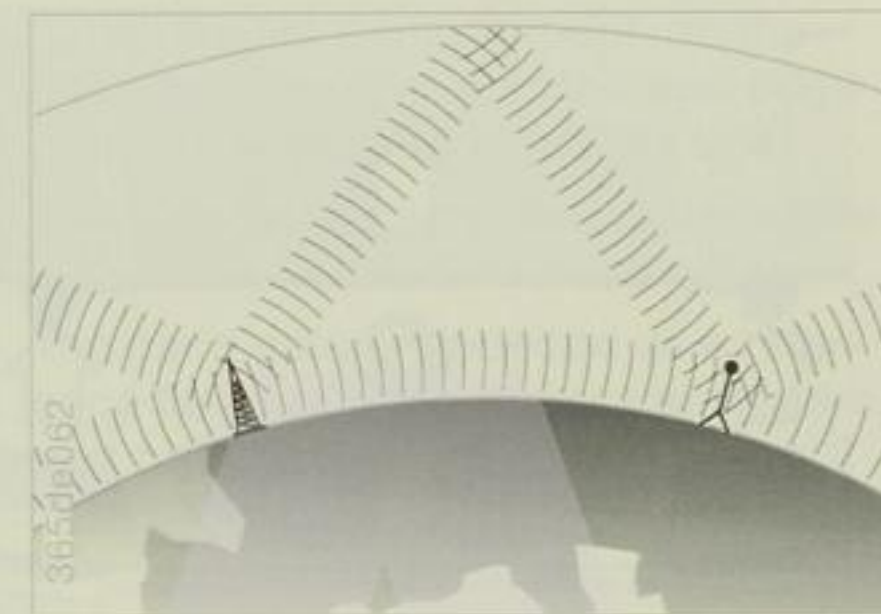

The MW, LW and SW wavebands can be heard a long way from the transmitter, because the signals spread out both as ground waves and through the air, reflected by the ionosphere.

VHF (FM) reception provides far higher listening quality than any of the AM wave bands. However, a VHF transmitter's range is limited to about 100 kilometres, since the signals travel only by line of sight.

Car phones not recommended by BMW or other mobile phones could cause radio interference. This takes the form of a low-pitched humming in the loudspeaker system.

Car phone*

Mobile communication systems (car telephones, two-way radio etc.) can cause interference if they are not approved for use in your car. Since BMW cannot examine and test each product, it is unable to accept any responsibility for the installation of items it has not approved. Before purchasing any such equipment you are recommended to consult your BMW service station.

Furthermore, in order to safeguard your BMW's operating reliability, do not operate any in-car telephones or other mobile radio equipment with an aerial inside the car or with an aerial which is not attached to the outside of the car.

Detach the car phone aerial before driving on to a car train.

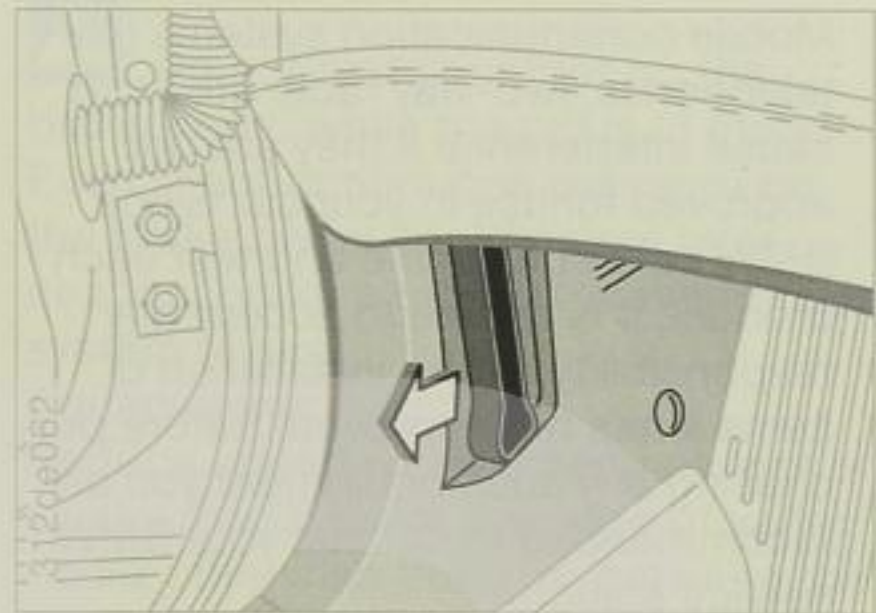

Releasing

Pull the lever at the left under the fascia.

! Switch off the engine and allow it to cool down before performing any work inside the engine compartment. Always disconnect the batteries before any work is commenced on the electrical system, particularly inside the engine compartment. Careless or incorrect handling of parts and materials when working on the car represents a personal safety risk. Please study and comply with the relevant instructions. If you are not familiar with the regulations governing the intended work, entrust it to BMW Service instead. ◀

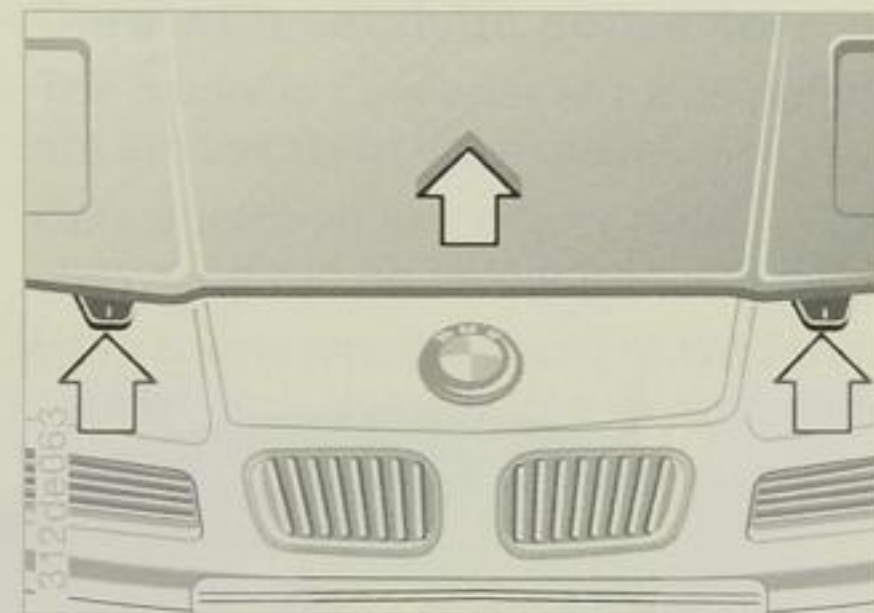

To open:

Press the two sliding catches (arrows) to the rear and raise the lid.

Engine compartment light

This comes on when the engine compartment lid is raised, if the car's main lights are on.

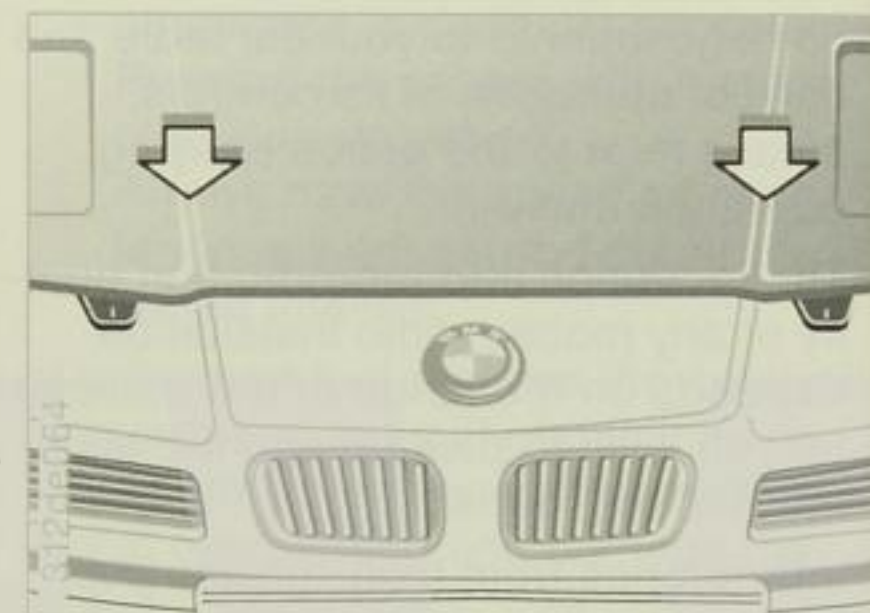

To close:

Press both sides of the hood panel down at the same time until it is heard to engage.

! When closing the engine compartment, keep the hands clear of the apertures for the pop-up headlights, or injury may result. Should you notice while driving the car that the engine compartment lid is not properly secured, stop at once and close it correctly. ◀

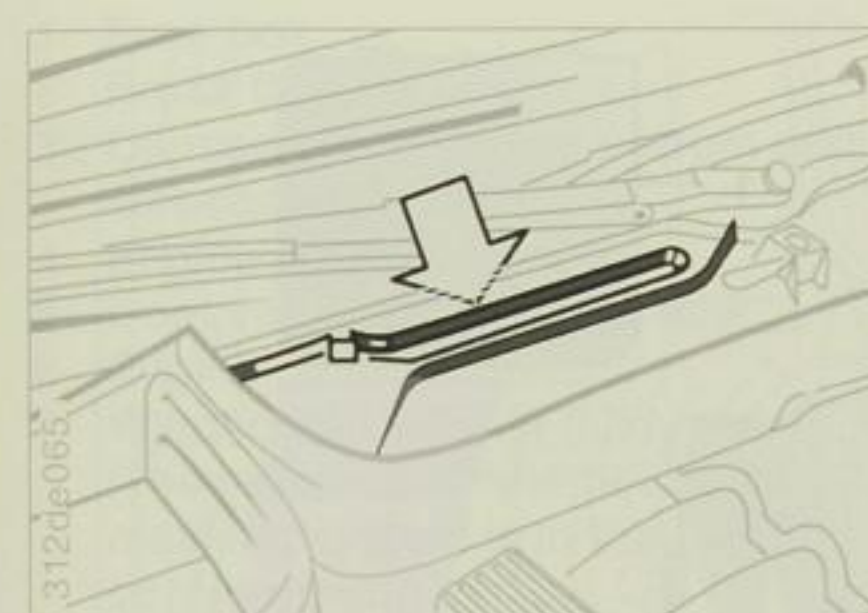

Vehicle identification number

This is located in the engine compartment, behind a gusset plate and next to the right windscreen wiper pivot shaft (arrow); it may also appear on the top of the fascia, at the left.

In the engine compartment, on the right side panel next to the rear edge of the right pop-up headlight unit.

The data on the type plate must agree with those in the car's documents.

The car's data are needed as a reference for all queries, checks and spare part orders.

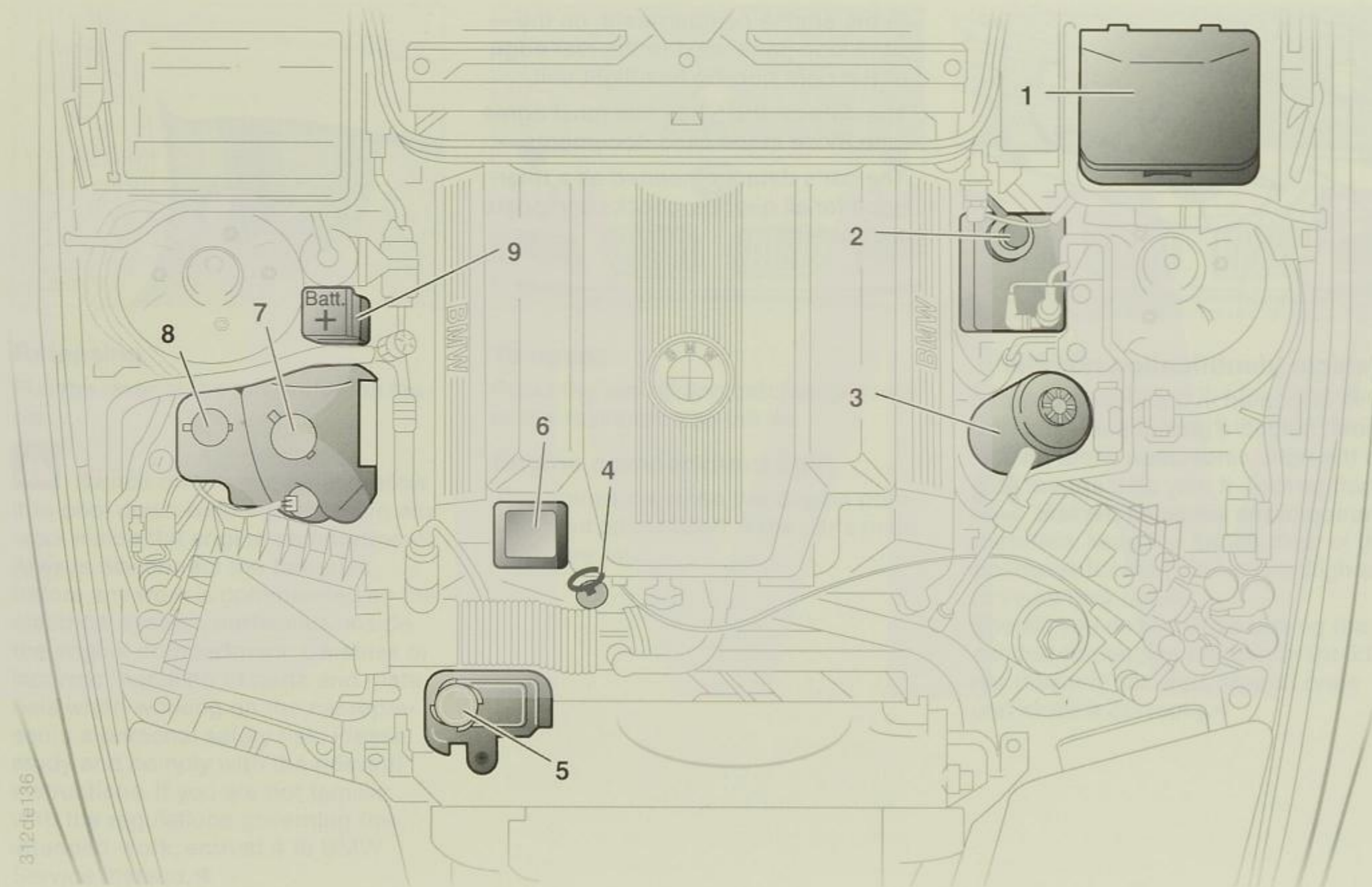

- 1 Fuse box
- 2 Brake fluid reservoir
- 3 Oil reservoir for brake system and steering hydraulics
- 4 Engine oil dipstick
- 5 Coolant level equalizing tank
- 6 Engine oil filler cap
- 7 Windscreen washer fluid reservoir
(The reservoir for the headlight cleaning system is in the luggage compartment)
- 8 Reservoir for intensive cleaning system
- 9 Connection for jump starting

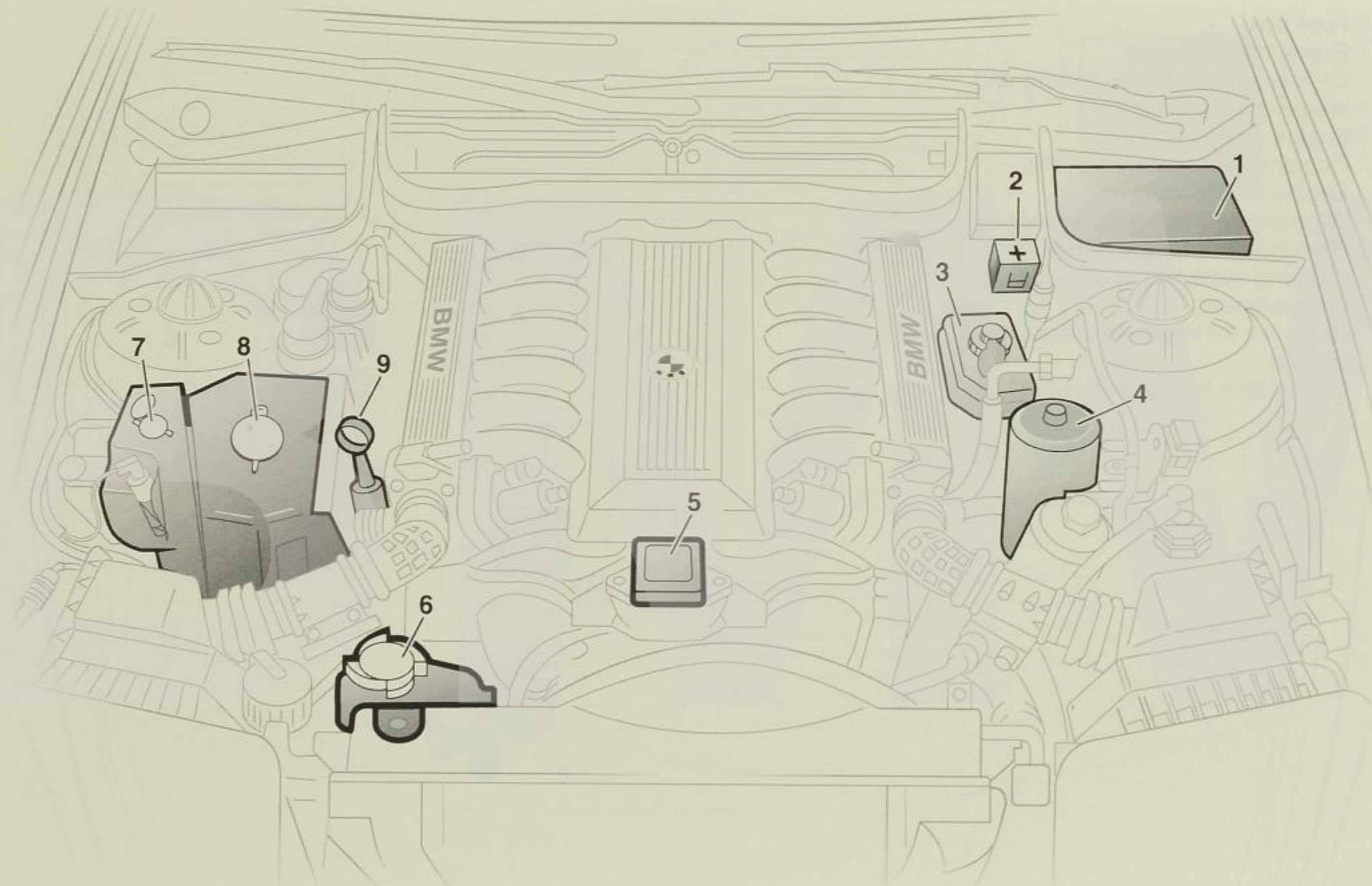

- 1 Fuse box
- 2 Connection for jump starting
- 3 Brake fluid reservoir
- 4 Oil reservoir for brake system and steering hydraulics
- 5 Engine oil filler cap
- 6 Coolant level equalizing tank
- 7 Reservoir for intensive cleaning system
- 8 Windscreen washer fluid reservoir (The reservoir for the headlight cleaning system is in the luggage compartment)
- 9 Engine oil dipstick

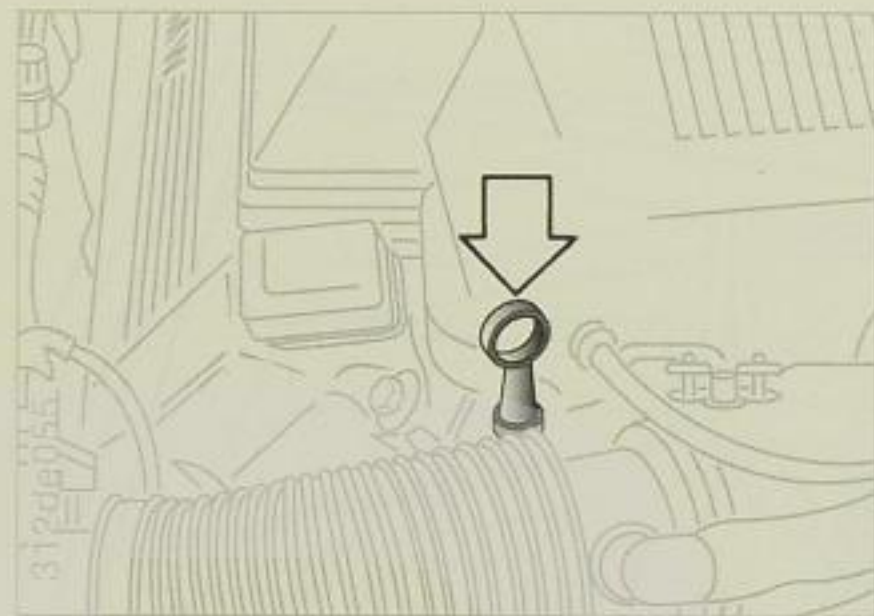

Maximum measuring accuracy:

Before a cold engine is started.

If the engine is already at its normal operating temperature, wait a short time so that the oil can drain back in the sump (for instance while refueling).

Push the dipstick fully into its tube.

Examine the oil level: it must be between the two dipstick marks.

Motor- checking oil level

Like fuel consumption, engine oil consumption depends on driving style and operating conditions.

The oil level should therefore be checked regularly, approximately every 1000km (approx. 600 miles), or sooner if the car has been driven hard. The car should stand on a flat, level surface.

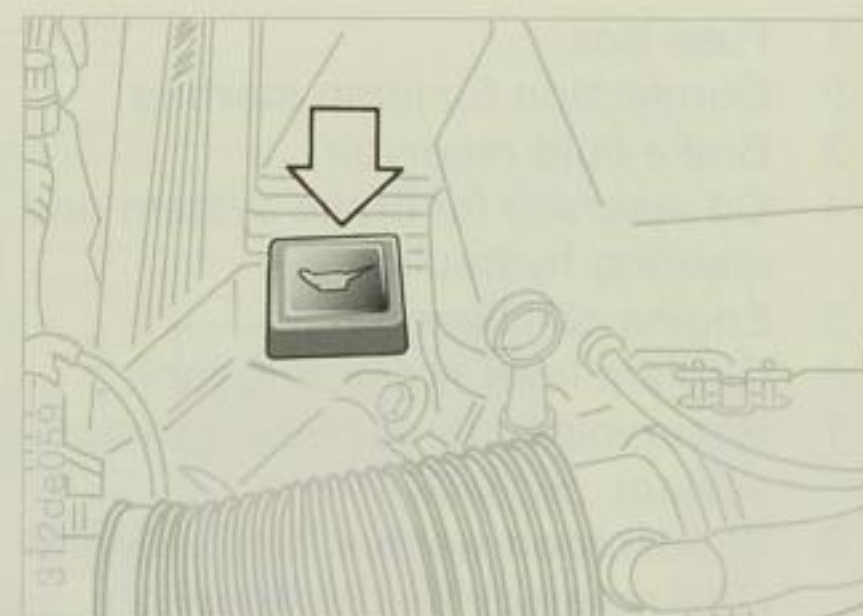

Motor- adding engine oil

Do not add more oil until the level has fallen almost to the lower mark on the dipstick. However, the oil level must not fall below the minimum level mark.

The space between the two dipstick marks represents approx. 1 litre (1.8 Imp. pints) of oil. Never add oil beyond the upper dipstick mark. Adding too much oil will harm the engine because it will be burned off more rapidly, thereby implying that consumption was too high.

BMW engines are designed not to need separate additives in the engine oil, and adding these substances could even be harmful. The same applies to the gearbox or automatic transmission, the final drive and the power steering.

Engine oil

Engine oil specifications

The grades of engine oil to be used are exclusively governed by the CCMC or API specification.

Required quality stages:

Preferred:	Also permitted
CCMC-G4	API SG
CCMC-G5	API SH
CCMC-G4/PD2	API SG/CD
CCMC-G5/PD2	API SG/CE
	API SH/CD
	API SH/CE

When disposing of used oil, please comply with environmental protection laws.

Recommendation:

Always have oil changes carried out by the BMW Service station.

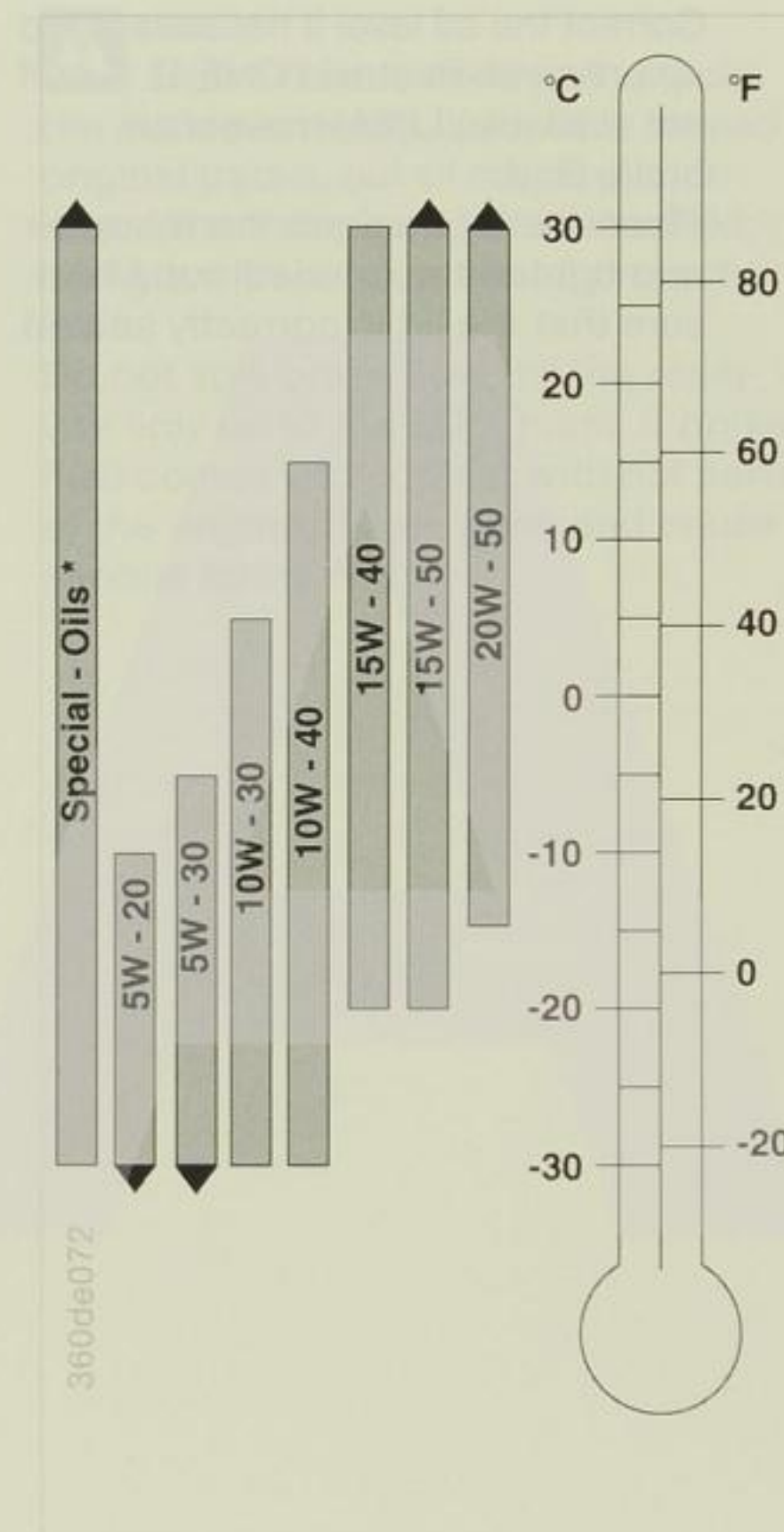

* Engine oils to CCMC-G5 or CCMC-G5/PD2 specification, individually approved by BMW

Viscosities

(The oil's liquid density, as shown by the SAE classification)

The choice of SAE grade depends on the average air temperature at the time of year.

The correct SAE grade is shown in the chart.

Note that the temperature limits indicated for the various SAE grades can be departed from for brief operating periods.



In laboratory tests, prolonged contact with used oils has caused cancer. For this reason, always wash the affected skin areas thoroughly with soap and water after work. Keep oils, greases etc. out of children's reach and in vessels marked with a suitable warning. ◀

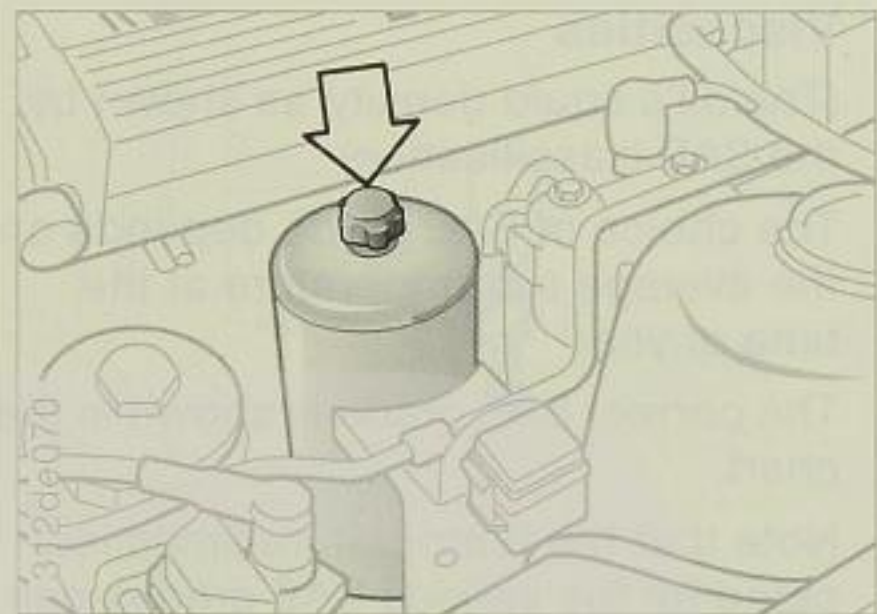

Checking oil level for brake system and steering hydraulics

- ▷ With the engine stopped, unscrew the knurled nut and take the lid off the reservoir.
- ▷ Depress the brake pedal about 10 times until the oil level in the reservoir no longer rises and increased resistance is felt at the pedal.
- ▷ Check oil level: it must be about 20 mm (0.8 in) below the rim of the reservoir.

- ▷ Correct the oil level if necessary. Top up only with Pentosin CHF 11 S or, if not available, LHM – never use brake fluid.
- ▷ Place the lid back on the reservoir and tighten the knurled nut. Make sure that the lid is correctly seated.



Oil for brake system, steering hydraulics and ARK*

(ARK = Active Rear Axle Kinematics)
If the display CHECK P.A.S. FLUID appears on the MID, consult BMW Service.

In an emergency:

- ▷ With the engine stopped, unscrew the knurled nut and take the lid off the reservoir.
- ▷ Add 0.25l Pentosin CHF 11S or, if unavailable, LHM.
- ▷ If the display remains visible in the MID, add a further 0.25l.
- ▷ Place the lid back on the reservoir and tighten the knurled nut. Make sure that the lid is correctly seated.

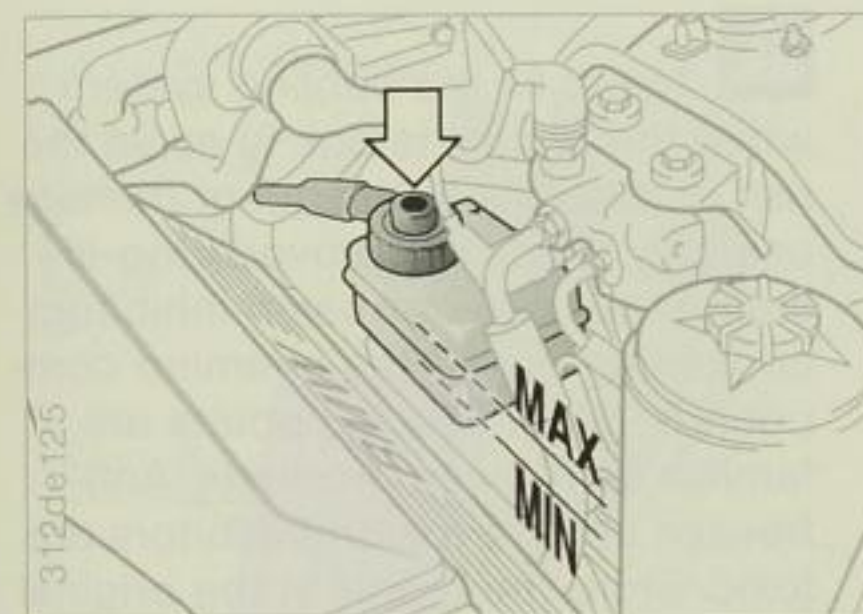

Fill to the upper MAX mark (level can be checked from the outside).

BMW Service points are familiar with the factory-approved brake fluids (DOT 4).

- ▷ **!** Brake fluid is hygroscopic, that is to say it absorbs moisture gradually from the air. To ensure that the brake system remains fully operational, the brake fluid must be renewed every 2 years by BMW Service. ◀

Please note the instruction on Page 106.

- ▷ **!** Brake fluid is toxic and attacks the car's paintwork. Keep it in sealed original packs, out of reach of children. When disposing of brake fluid, comply with environmental protection laws.
- ▷ Do not spill brake fluid; fill the reservoir only up to the MAX mark. If brake fluid comes into contact with hot parts of the engine, it can ignite and cause serious burns. ◀

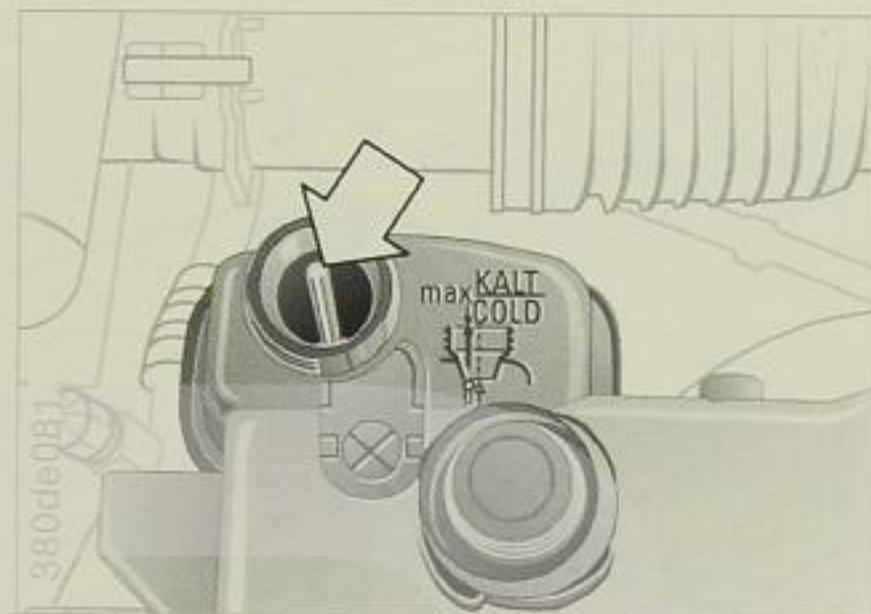

Coolant level with engine cold (app. 20°C):

Unscrew the reservoir cap.

The coolant level is correct if the top end of the red float rod is level with the top edge of the filler pipe (see arrow in illustration, or drawing on tank).

The coolant consists of water to which a long-life antifreeze and corrosion inhibitor has been added. The 50:50 mixing ratio must be maintained all the year round to ensure protection against corrosion. No other additives are needed.

Renew the coolant every 3 years.

Adding coolant to system:

Open the cap on the equalizing tank only when the engine has cooled down. The pointer of the coolant thermometer must be in the blue zone, or else there is a risk of scalding.

- ▷ Turn the filler cap counter-clockwise slightly until the excess pressure has escaped, then remove it.
- ▷ If the level is too low, add coolant slowly until the level is correct – do not overfill.



Never fill the cooling system when the engine is hot. To avoid the risk of possible subsequent damage, use only factory-approved long-life antifreezes and corrosion inhibitors containing no nitrites or amino compounds. BMW Service points are familiar with these products. Antifreezes and corrosion inhibitors are toxic. Store them only in the original packs, out of reach of children. Long-life antifreeze and corrosion inhibitor contains the flammable component ethylene glycol. Take care not to spill long-life antifreeze and corrosion inhibitor on hot parts of the engine, otherwise it can ignite and cause serious burns. ◀

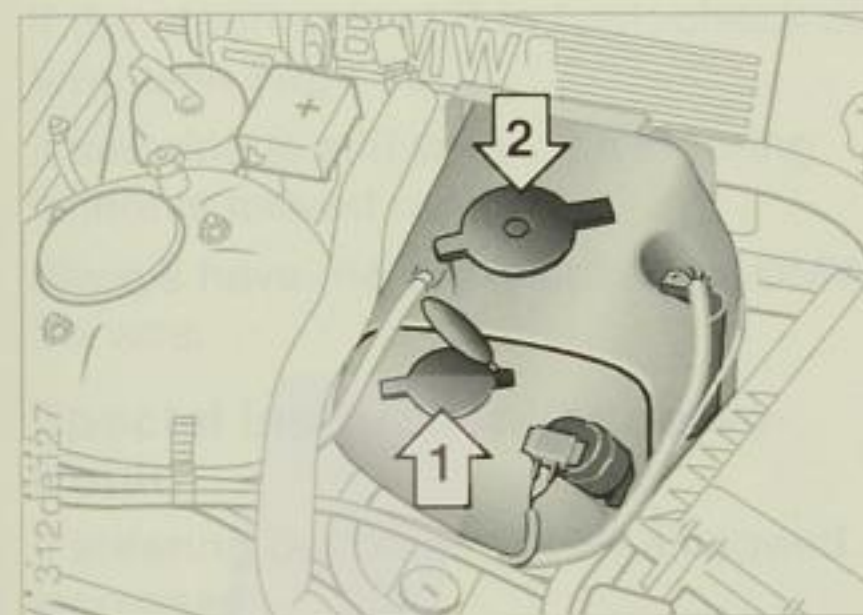

Intensive cleaning system (1) Small cap

Capacity app. 1.0litre (1.8 pints).

Fill with intensive cleanser (for frost protection down to app. -27°C, available from BMW Service).

Windscreen washer (2) Large cap

Capacity app. 2.5litres (4.4 pints).

Fill with water and add antifreeze if required (comply with the manufacturer's instructions).



It is advisable to mix the washer fluid before adding it to the systems. ◀

Combined windscreen and headlight cleaning system*

Add fluid at the filler pipe in the luggage compartment cutout (see next picture).

On vehicles with ARK (Active Rear Axle Kinematics) the front reservoir can also be reached directly for filling.

Capacity app. 9.0litres (15.8 pints), or app. 6.0l (10.5 pints) on vehicles with ARK.

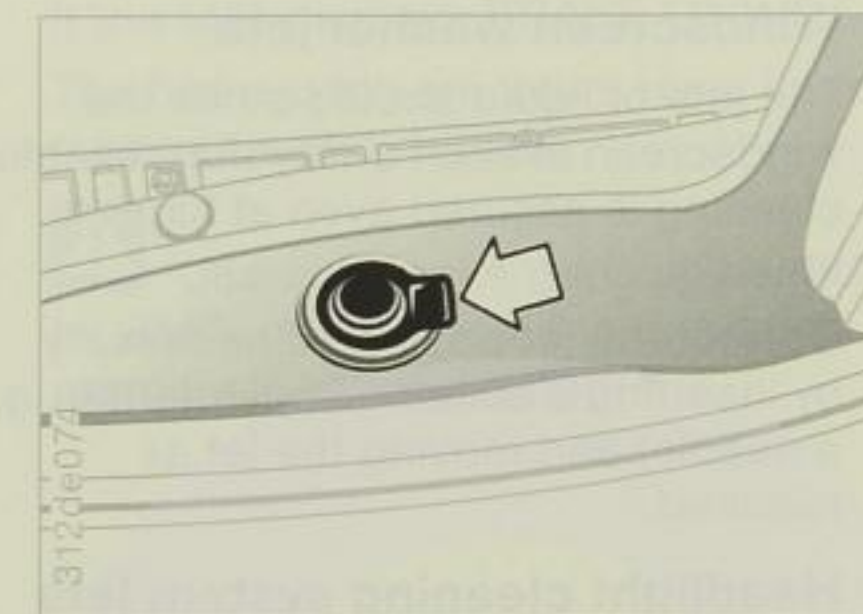

Fill with water and add antifreeze if required (comply with the manufacturer's instructions).



Only add cleaning agents and antifreeze after diluting with water, e. g. never in their concentrated form, to prevent causing any damage to the rear light. ◀



Do not operate washers when the reservoirs are empty. ◀

Windscreen washer jets

The jets of liquid should strike the windscreen in such a way that reliable cleaning is assured even at high speeds.

Correct the jet position if necessary by inserting a suitable implement (e. g. a needle) and moving the jet as required.

Headlight cleaning system jets

Have these jets adjusted by BMW Service if necessary.

Power steering

If the steering is stiff to turn: check oil level, see Page 98.

If steering is stiff when the steering wheel is moved rapidly:

Always have the car checked by BMW Service.

Special instruction for Servotronic*

If steering becomes lighter as speed increases:

An electronic fault has occurred.

 If the power assistance should fail, greater effort will be required at the steering wheel. ◀

Brakes

If the warning light for the brake and steering hydraulics comes on and LOW BRAKE FLUID is displayed on the MID:

Brake fluid has been lost from the system, causing pedal travel to increase.

Failure of one brake circuit

Brake pedal travel increases and higher pedal pressure is needed.

The car can still be braked effectively with the intact brake circuit.

However, you should take the car to BMW Service without any delay if a brake system malfunction occurs.

If the warning light flashes and the MID displays BRAKE ASSIST INACT., the following faults may have occurred:

- ▷ If increased brake pedal pressure is needed: loss of reservoir pressure, no brake servo action
- ▷ If the power steering becomes heavier to turn: loss of system pressure, no power assistance
- ▷ If brake pedal pressure is higher and the steering heavier to turn: the hydraulic pump has failed or the V-belt has broken.

If the MID displays BRAKE LININGS: The brake pads are worn. Have them renewed without delay.

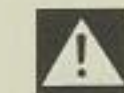

Use only brake pads approved by BMW, or else the car's operating permit will be invalidated. ◀

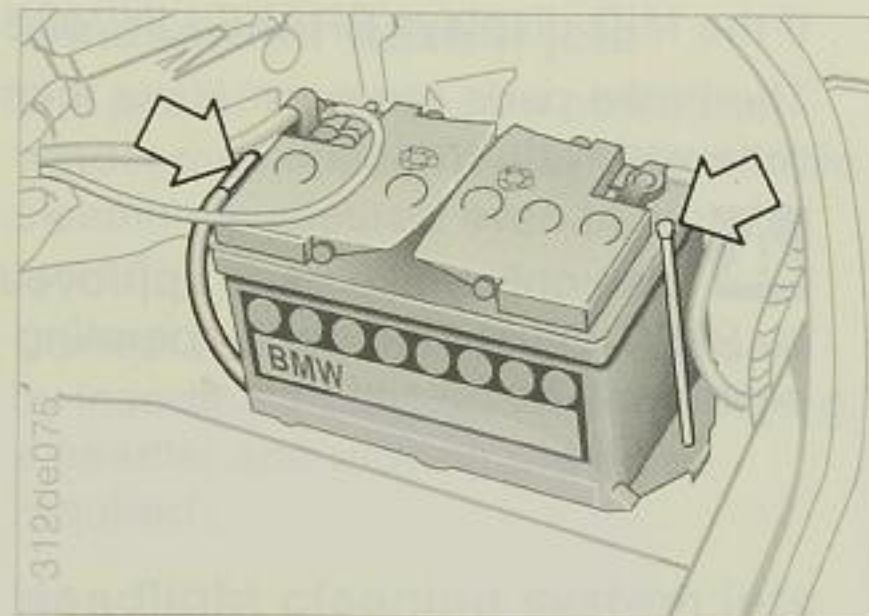

The two batteries are located behind the side trim panels in the luggage compartment. There is a positive terminal connection in the engine compartment, to which a jump-start lead can be attached if necessary (see Page 110).

The batteries are maintenance-free to German DIN 43539/2 standard, that is to say their acid content normally lasts for the lifetime of the battery.

If the acid level drops too low, for instance if the car is used for lengthy periods in a hot climate, top up with distilled water (not acid).

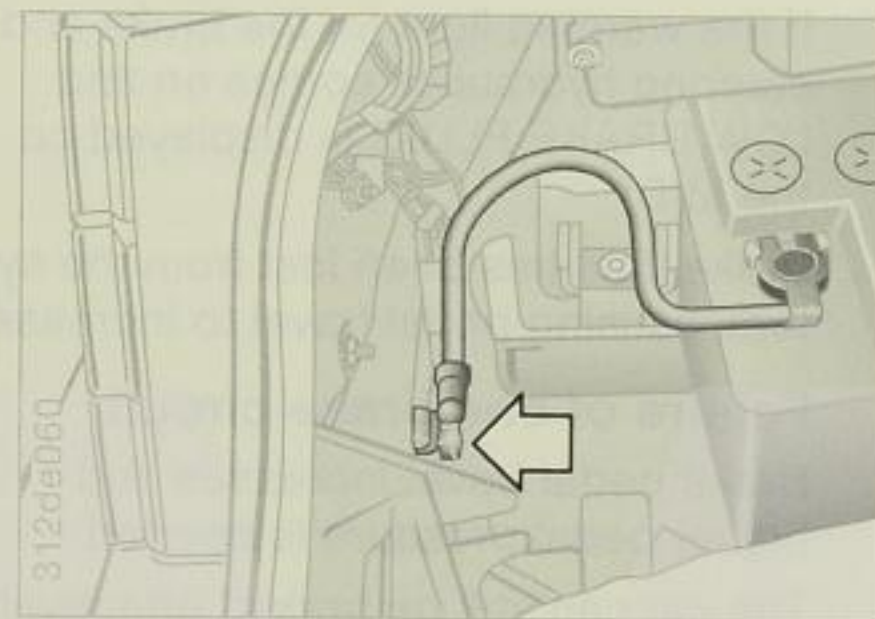

Acid level: up to the MAX mark on the outside of the battery in each cell (app. 5mm above the tops of the plates of the cells).



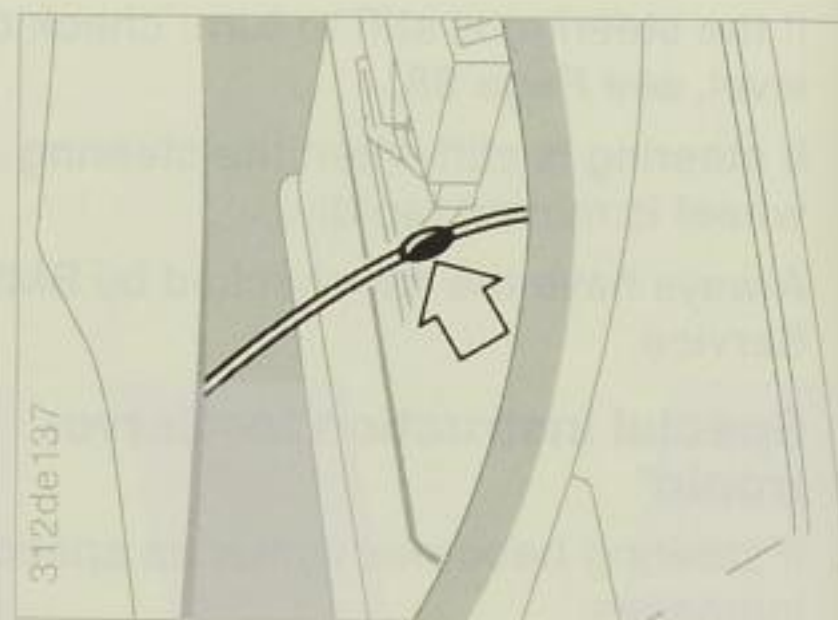

Keep the tops of the batteries clean and dry.

 Never disconnect one of the batteries only. Before removing, either detach the negative terminals at both batteries or their common earth (ground) strap at the body (see arrow). ◀



Before taking off the right-hand luggage compartment side trim, separate the plug connector for the manual fuel filler flap release at the cable (arrow).

Batteries

-  Read the following instruction before undertaking any work on the batteries:
-  Always wear eye protection. No particles containing acid or lead should be allowed to reach the eyes.
-  Battery acid is highly toxic. Wear protective gloves and suitable glasses or goggles. Do not tilt the battery, otherwise acid could leak out through the gas vents.
-  Keep children away from batteries.
-  Avoid fire, sparks, or naked flames close to the battery. Do not smoke. Try to avoid sparks when using cables or from other electrical equipment. Avoid short-circuits. Never short-circuit the battery terminals. The powerful arc which results could cause severe injury.
-  When the batteries are charged, a highly explosive gas mixture is emitted and can detonate.

 If any splashes of acid reach the eyes, rinse them out immediately for some minutes with clean water. Consult a physician without delay. Neutralize acid spillage on the skin or clothes immediately with soap and rinse off with plenty of water. If acid has been swallowed, consult a physician immediately.

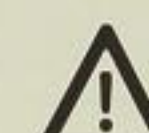
 To protect the battery case from ultraviolet rays, keep batteries away from direct daylight. As batteries which have run flat could freeze, store in a place where there is no risk of frost damage.

Removing and installing

 Never detach the battery leads when the engine is running, or else an overvoltage will occur and damage the car's electronic equipment beyond repair. ◀

When removing, first disconnect the negative poles, then the positive poles and pull off the degassing tank at the side. Unscrew the battery retaining clamp.

When installing, make sure that the batteries are firmly secured, then connect the positive poles first, followed by the negative poles.

Recharging the battery

Recharge the batteries in the car only with the engine stopped. On cars with a connection provided in the engine compartment it is easier to recharge the batteries by way of this connection and the earthing point in the engine compartment (see "Starting with a flat battery", Page 110).

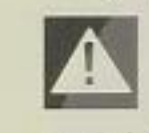
 To avoid short-circuits, disconnect both negative terminals from each battery or detach the common earth (ground) cable before starting any work on the electrical system. ◀

If the car is to remain out of use for more than four weeks, disconnect the batteries from the car's electrical system by detaching the batteries' negative post clips.

If the car is to remain out of use for more than six weeks, remove the batteries, recharge them and store them in a cool place (but protected against frost). Recharge the batteries at least every three months, or they will be rendered useless. Every time the battery goes flat, particularly if left in this state for any length of time, its operating life is reduced.

If one of the batteries is defective or has to be renewed, two new batteries of identical make and type must always be installed.



Return discarded batteries to a collecting point for used batteries or to BMW Service. When filling, always carry or store batteries upright. Protect batteries against falling over when in transit. ◀



Periods of time in which the car's battery is disconnected are disregarded by the service interval indicator when calculating the need for brake fluid renewal. Take any such periods into account with regard to the two-yearly brake fluid renewal interval, and do not wait until the clock symbol lights up. ◀

Fuses

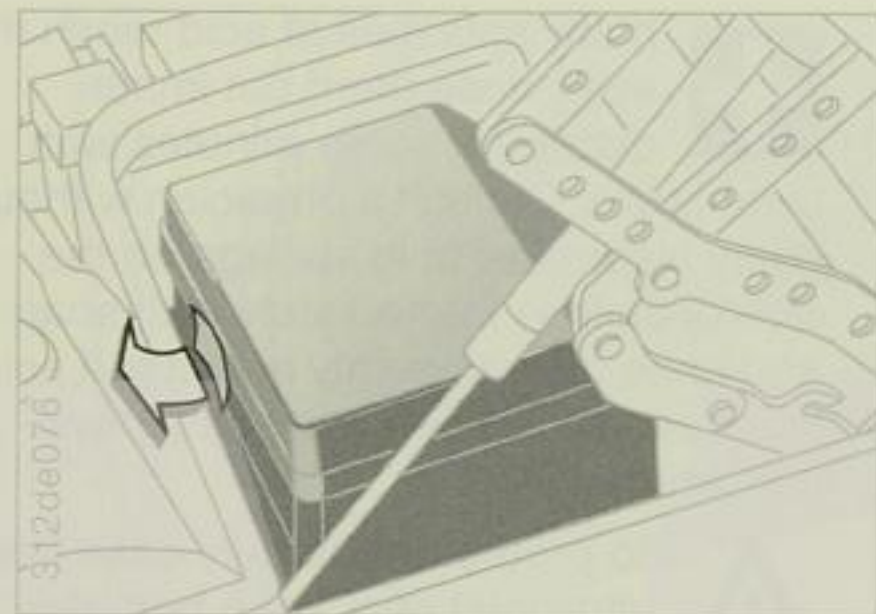

If an electrical consumer fails, switch it off and check its fuse.

The fuse box (electrical distribution box), with spare fuses, relays and plastic pincers, is on the left inside the engine compartment.

- ▷ Press the retaining flap in and lift off the cover.
- ▷ Use the plastic pincers to remove the blown fuse from its holder.
- ▷ A blown fuse can be recognized by its melted metal wire.

There are more fuses behind the left trim panel in the luggage compartment. On cars with Check Control and a trailer tow hitch, there are additional fuses for the trailer lights in the trailer module in the luggage compartment, behind the left side trim. The fuse for the permanently positive line is located next to the battery, in a separate fuse box.

A list of fuses with ratings in Amps and details of the electrical consumers supplied is given on each fuse box cover.



Never attempt temporary repairs to fuses with unsuitable materials. ◀

If a fuse blows several times in succession, ask BMW Service to trace and rectify the fault.

Toolkit

Under the luggage compartment lid, accessible after unscrewing the wing bolt.

Warning triangle*

Space is provided in the toolkit to accommodate the warning triangle in an accessible position.



Please note that you may be required by law to carry a warning triangle on the car. ◀

Fire extinguisher*

There is a mounting on the driver's seat.

To ensure full operating reliability, have the fire extinguisher examined by a service station authorized by the manufacturer every 2 years.

If these service stations are not listed on the extinguisher or in any documentation available to you, please consult a local trade directory or the yellow pages of the telephone service to obtain the address.

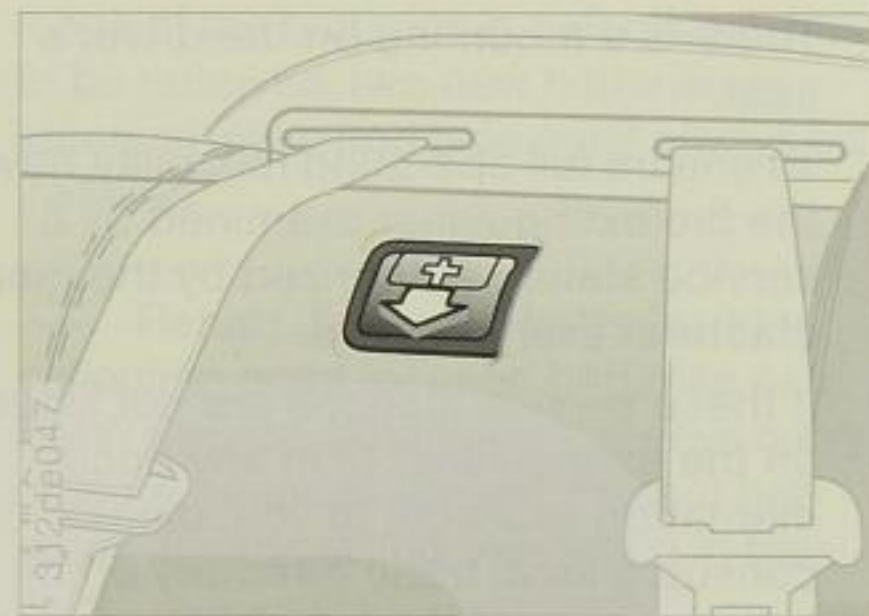

Between the rear seats. Pull the catch (arrow) down and swing the cover forwards.



Certain items in the first aid kit have a limited useful life. Please check the contents regularly and renew life-expired items in good time. Replacements can be obtained from any pharmacy.

Comply with legal requirements concerning the need to carry a first-aid kit in the car. ◀

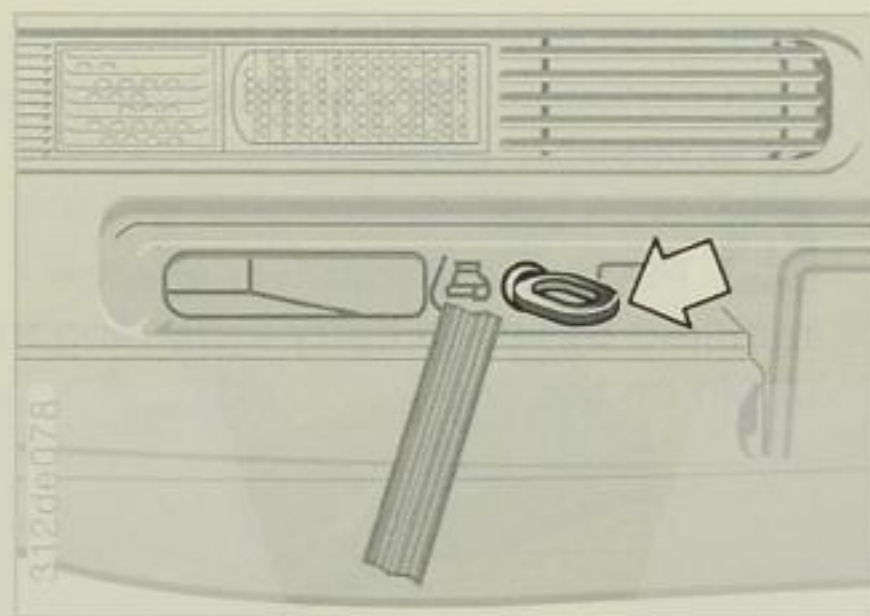

The screw-in towing eye is kept in the toolkit and must always be carried. It can be attached to the car at the front or rear.



Always screw in the towing eye fully. ◀

Screwing in at front

Pull the left side of the cover out and remove it.

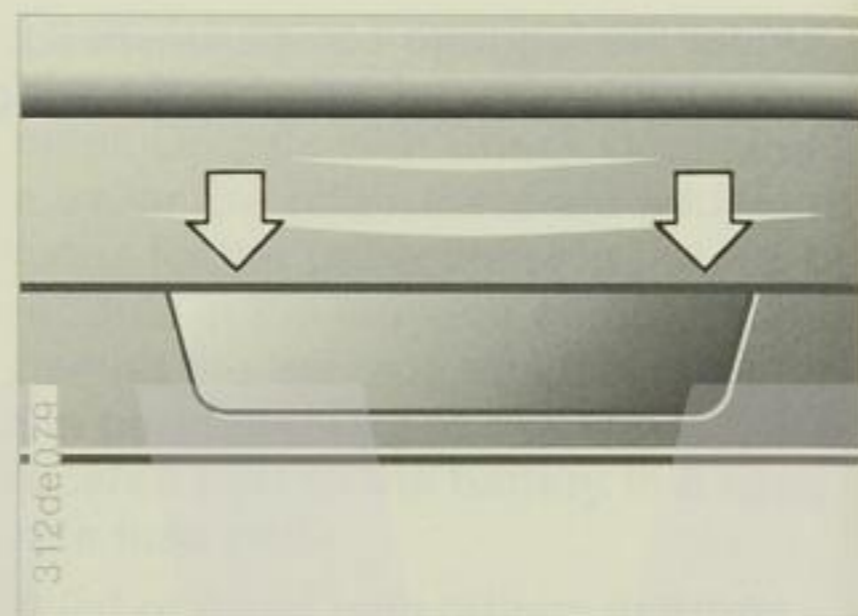
**Screwing in at rear**

Press the cover down at its left and right ends by inserting a screwdriver into the upper joint line (see arrows in picture).

On cars with a trailer tow hitch, the threaded hole is next to the ball head mounting.

To insert the cover, place it in the guide at the bottom and press in at the top.

For towing, either a rigid towbar or a nylon rope or tape should be used (the latter have the advantage of being resilient, so that peak loads are avoided).

Towing with a rigid bar:

The towing eyes of both vehicles should be on the same side.

If the towbar has to run at an angle, note the following:

- ▷ Clearance may be restricted when turning corners.
- ▷ If the towbar runs at an angle, lateral forces will be generated (these may be critical on a slippery surface).
- ▷ To compensate for towbar angularity, the two vehicles cannot always be driven one directly behind the other.
- ▷ If the towing vehicle's brakes are applied, the other vehicle may overrun it or skid sideways.



The towed vehicle should not be heavier than the towing vehicle. ◀

Cars with catalytic converter should only be tow-started if the engine is cold. It is always preferable to use jumper leads from another car or a separate battery to start the car.

- 1 Switch on the hazard warning flashers (comply with national regulations regarding their use).
- 2 Turn the ignition key to position 2.
- 3 Select third gear.
- 4 Keep the clutch pedal down. When the car is moving, gradually release the clutch pedal. When the engine has fired and is running, depress the clutch pedal again.
- 5 Switch off the hazard warning flashers.

Have the cause of the starting problem traced and rectified by BMW Service.

Cars with automatic transmission

These cars cannot be tow-started. For starting with a flat battery, see next page.

- 1 Turn the ignition key to position 1 so that the brake lights, turn indicators, horn and wipers can be operated.
- 2 Switch on the hazard warning flashers (comply with national regulations regarding their use).

If the car's electrical system has failed, display a warning notice to the rear or place the warning triangle in the rear window.



Please make sure that the ignition key is turned to position 1 even if the electrical system has failed, to prevent the steering from locking. ◀

Cars with automatic transmission

- ▷ Move the selector lever to N.

Maximum towing speed: 50 km/h (app. 30 mile/h)

Maximum towing distance: 50 km (app. 30 miles)

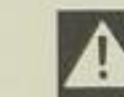

When the engine is not running, there is no power assistance and the brake servo is out of action. The steering and brakes will require extra effort to operate. ◀

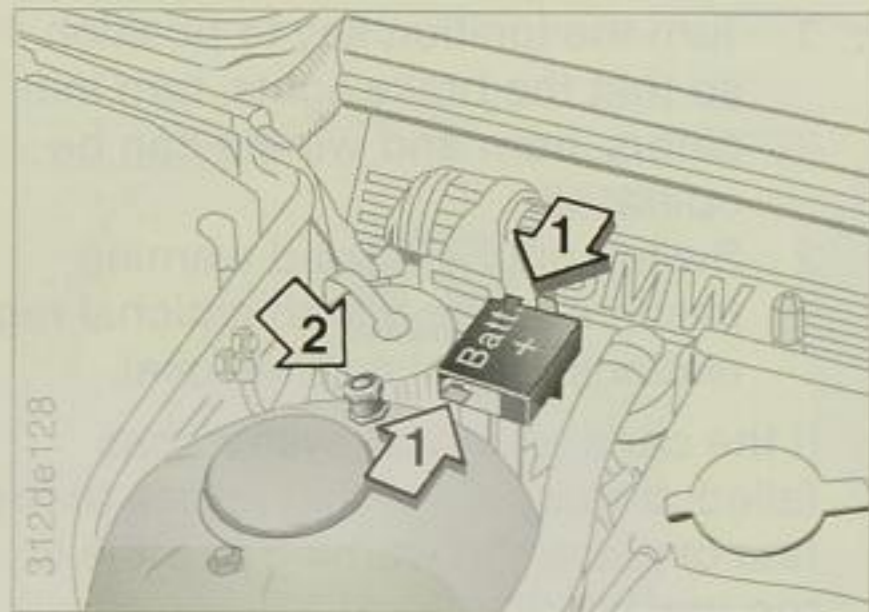

Do not use spray products sold as an aid to starting.

If the car's own battery is flat, the engine can be started by using two jumper cables from another vehicle's battery.

! Touching electrically live components while car's engine is running can cause a potentially fatal accident. ◀

Do not depart from the procedure described below, or else personal injury could result or one or both vehicles be damaged.

- 1 Check that the other vehicle has a 12 Volt battery of approximately the same capacity (65Amp/h). This should be printed on the battery.
- 2 Do not disconnect the flat battery from the car's electrical system.
- 3 The bodies of the two vehicles must not touch, or a short circuit could result.
- 4 First connect the positive terminal of the other car's battery with one of the jumper leads to the positive pole in the BMW's engine compartment (this has a protective cover marked + which can be removed by pulling the flap (BMW 850Ci, 850CSi) or by pulling the two flaps at the side (BMW 840Ci - see left picture, arrow 1). Then connect up the batteries' negative terminals. First attach the jumper lead to the negative terminal of the other vehicle's battery or to the other car's engine or body earth and then to the engine or body earth (nut on spring strut dome, see picture, arrow 2) of your own car.

! When connecting up jumper leads, including when assisting other vehicles, please work in the sequence stated above in order to prevent sparks occurring at the battery. ◀

- 5 If the second vehicle's battery is not well charged, run that vehicle's engine. Start your own car's engine in the usual way and leave it running. Before detaching the jumper leads from your BMW, switch on your car's lights, heated rear window and heater blower (at maximum speed) to ensure that the voltage reaching the consumers from the regulator is not too high. Then disconnect the jumper leads in the opposite order (negative pole first, then positive pole).

Have the battery recharged (depending on the cause of the fault).

! The car should ideally be positioned on a level, firm surface which affords a good grip if a wheel is to be changed. On a soft or slippery surface (snow, ice, tiles or similar) the car or the jack could slip sideways. The car jack should likewise rest on a firm surface.

Do not position wooden blocks etc. beneath the jack, as its maximum load capacity could otherwise be exceeded. Never lie under the car or start the engine when it is jacked up; a very severe or fatal injury could result. Additional safety precautions in the event of a flat tyre:

Where possible, take the car off busy roads and away from moving traffic. Allow the steering lock to engage in the straight-ahead position, apply the handbrake and select first or reverse gear or automatic transmission selector lever position P.

Switch on the hazard warning flashers. Request all occupants to leave the car and to wait in a safe place (e.g. behind roadside crash barriers).

If necessary, set up the warning triangle or a flashing warning light at a sufficient distance to the rear. Comply with national legislation in these respects. ◀

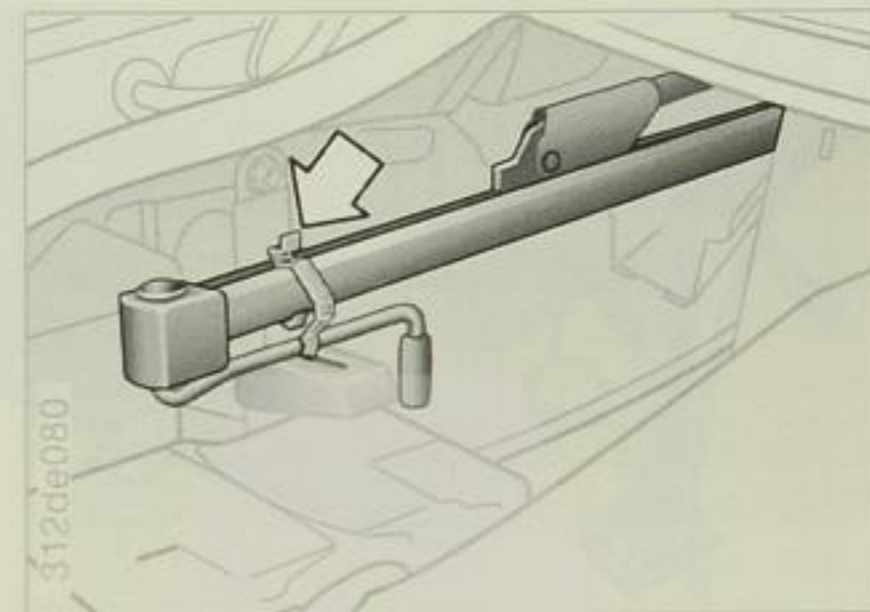

Jack

In the luggage compartment, behind the left trim.

To avoid rattling noises later, note how the various tools are attached to the car and replace them in precisely the same positions afterwards.

Pull the trim away at the pre-formed cut-out. Release the spring clip (arrow) and take out the jack.

After use, lower the jack fully, place its base in the holder and press it forwards.

Spare wheel and hexagon adapter

These are both under the mat in the luggage compartment. Take out the mat.

Take off the black hexagon adapter, unscrew the wing nut by hand and remove the wheel.

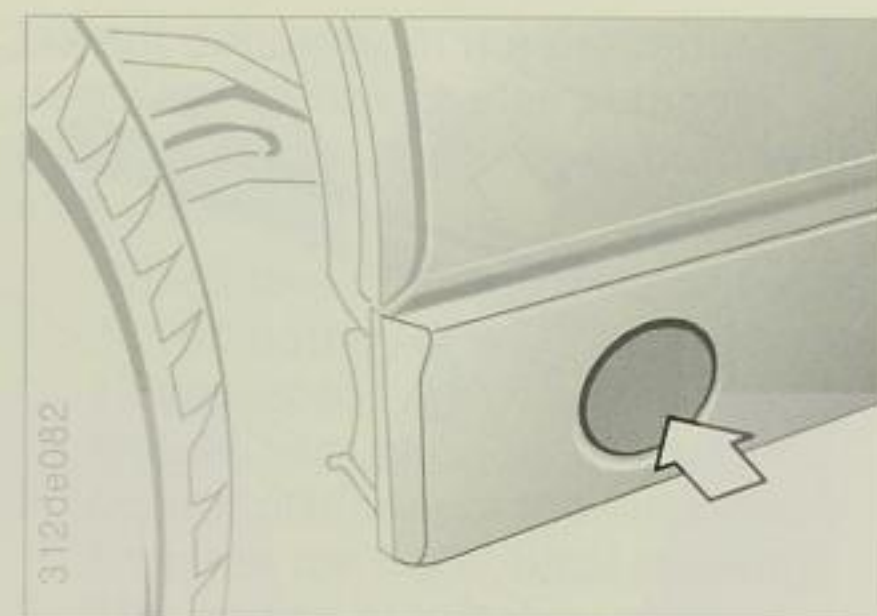
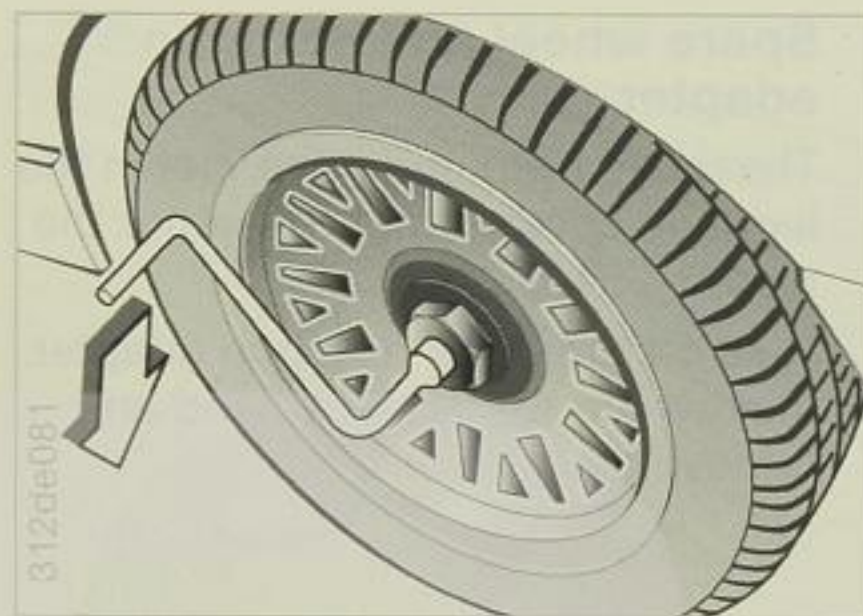
**Wheel changing procedure:**

- 1 Take off the wheel stud cover by applying the hexagon adapter and stud wrench to it and turning to the left. For thiefproof wheel studs, see Page 105.
- 2 Slacken the wheel studs by half a turn.
- 3 Press in and remove the jack attachment socket cover at the appropriate point of the car (arrow).
- 4 Insert the jack fully into the socket and position it so that the base is resting firmly on the road.
- 5 Raise the car's body with the jack until the wheel to be changed is clear of the road.



Use the jack only for wheel changing. Never attempt to lift another type of car or any other heavy object with it, as this could lead to accidents and personal injury. Do not lie under a jacked-up car – a very severe or fatal injury could result. ◀

- 6 Take out the wheel studs and remove the wheel.
- 7 Insert the centering pin from the car's toolkit into one of the threaded holes, with the plastic cap in position on it.
- 8 Offer up the new wheel, insert at least two of the studs at opposite points and take out the centering pin.

For light alloy wheels with turbine styling or with a directional turbine-style cover, please note:

These wheels or covers are asymmetric, and therefore intended to rotate in one direction only. The spare wheel matches the wheels on the right of the car; the spare wheel for the BMW 850CSi does not have a cover.

The wheel illustrated is on the left of the car.

If a puncture has occurred, the BMW 850Ci's spare wheel can also be fitted on the left of the car, but a wheel which rotates in the intended direction should be fitted instead as soon as possible.

The wheel cover can only be fitted by BMW Service or a specialist workshop.

Wheel stud wrench and centering pin
In the toolkit underneath the luggage compartment lid.

265/40 ZR 17 rear tires

In the event of a puncture, it may be necessary to use the spare wheel with a 235/45ZR17 tyre at the rear.

Although this wheel can be used entirely satisfactorily in all load and speed ranges, one with a tyre of size 265/40ZR17 should be fitted in its place as soon as possible.

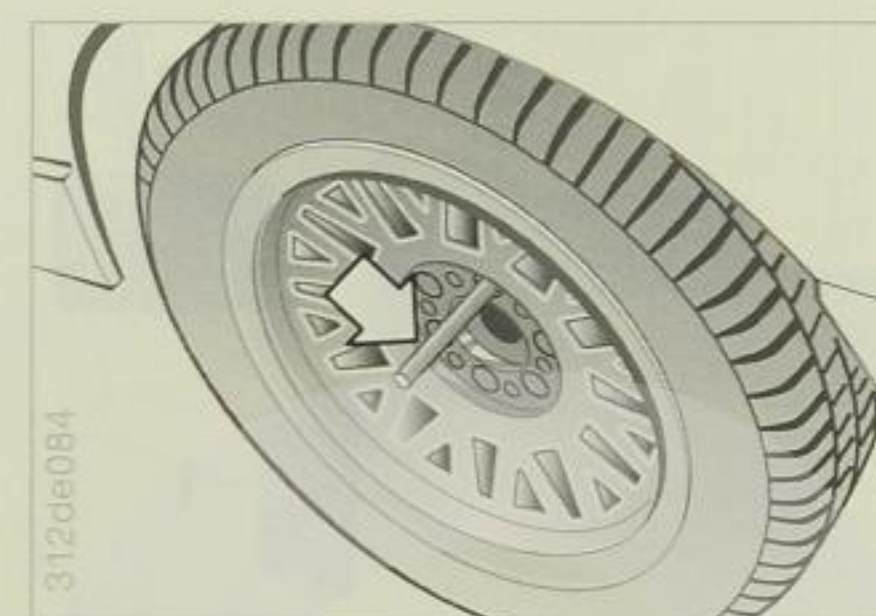
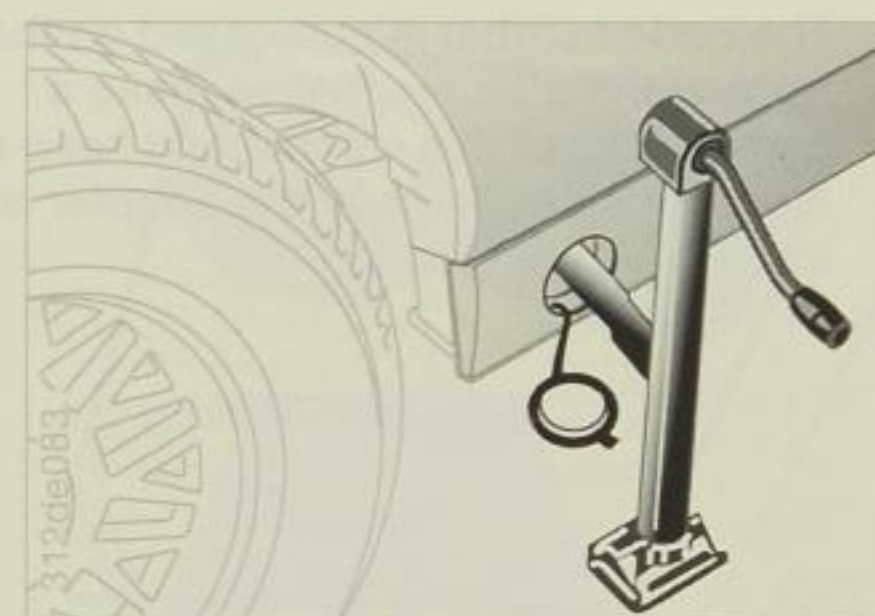

- 9 Screw in the remaining wheel studs and tighten them all in a crosswise pattern.
- 10 Lower the car, remove the jack, insert the jack attachment point cover with the flap at the bottom and press it in at the top.
- 11 Tighten the wheel studs fully, working in a crosswise pattern.



For safety reasons, the wheel studs should be checked with a calibrated torque wrench without delay to ensure that the specified tightening torque of 100Nm (74 lb.ft.) has been reached. If a new wheel (for instance the spare wheel) is fitted for the first time, check the tightening torque again after the car has covered 1000km (about 600 miles). ◀

- 12 Centre the wheel stud cover and attach. Push it on and turn to the left or right until wheel cap locks into place. Cross-spoke wheels: align with the arrow marked on the wheel stud cover with the line marked on the wheel and push on the wheel cover.

When replacing a wheel in the spare wheel well, make sure that the central threaded rod in the well is not bent or damaged.

If your car is equipped with wheels other than Original BMW light-alloy wheels, make sure that the correct wheel studs are used.

Have the flat or defective tyre repaired or replaced as soon as possible, and the new tyre balanced on the wheel.

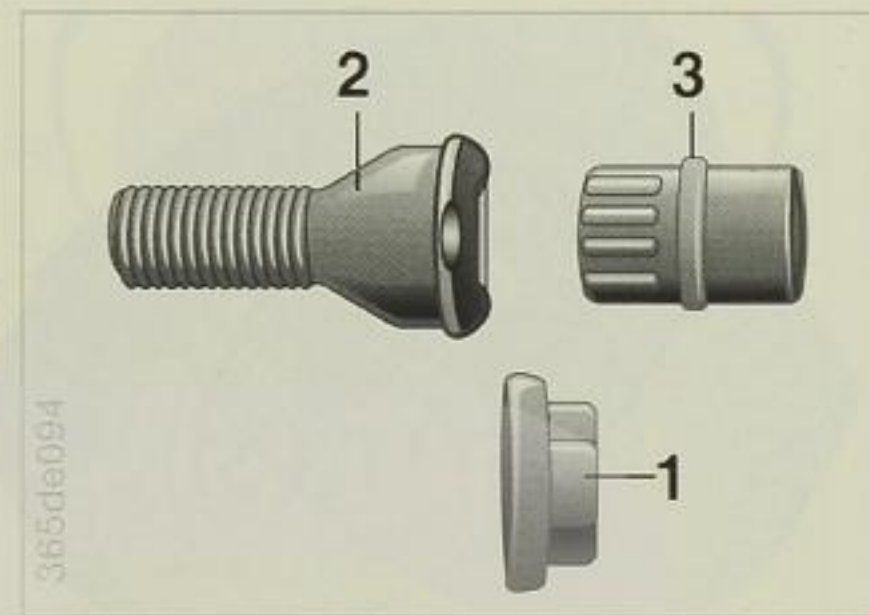

The code number is embossed on the front of the adapter. Please make a careful note of this number and keep it in a safe place, in case the adapter is lost.

- 1 Stud cap (not for wheels with wheel stud cover)
- 2 Wheel stud for adapter
- 3 Adapter (supplied in toolkit)

To remove:

- 1 Turn the cap (1) slightly to the left with the wheel stud wrench and remove it.
- 2 Take adapter (3) from the car's toolkit and insert it into the wheel stud.
- 3 Unscrew the wheel stud (2).

After inserting and tightening the wheel stud again, remove the adapter and press on the stud cap.

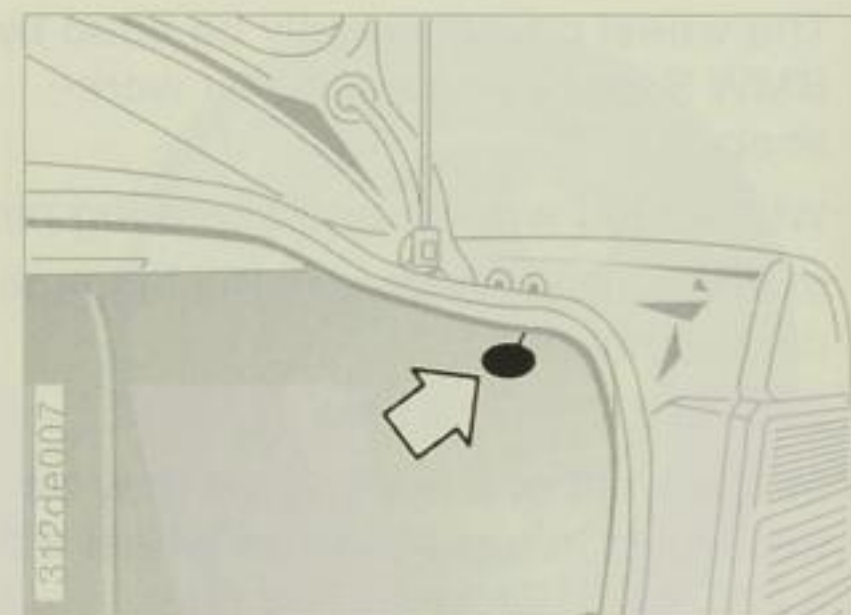

Manual release

Take the pull wire (arrow) out of the luggage compartment trim and pull it to the rear.

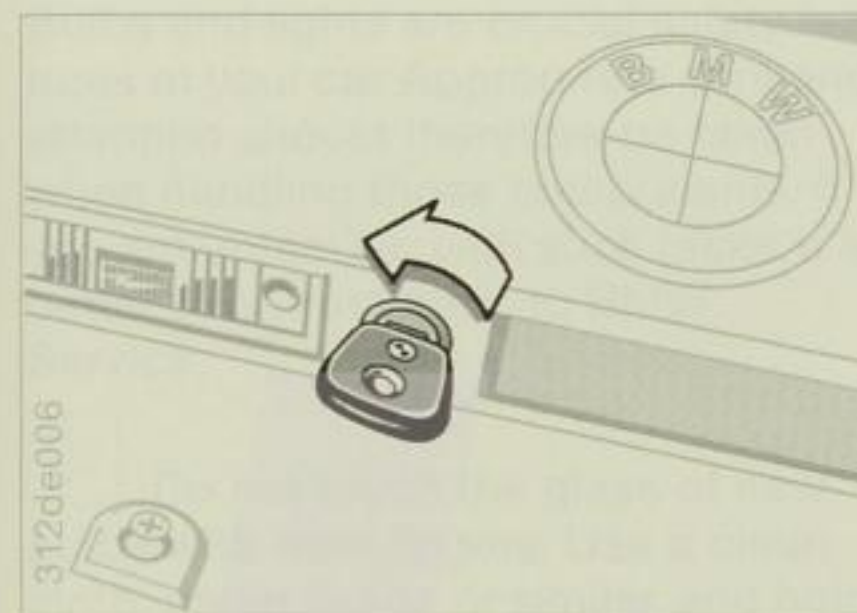

Manual release

- 1 Insert the master key into the lock next to the release button.
- 2 Turn the key and remove it again in the position in which it was inserted.
- 3 Press the lock barrel in.

The luggage compartment locks again as soon as it is closed.

▶ If the thiefproofing system has been activated, the alarm will be triggered off if the luggage compartment is opened manually. ◀

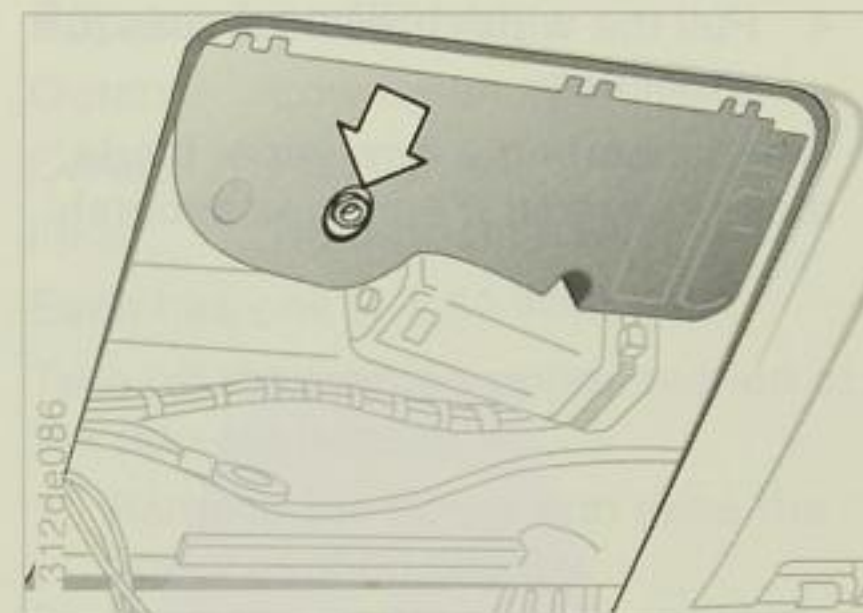

Manual operation

- 1 Press out the interior light by inserting a screwdriver into the cutout.
- 2 Take off the cover.
- 3 Use the Allen key from the car's toolkit to move the roof in the desired direction.

To ensure that the sunroof operates correctly after repair or restoration of the power supply, it has to be re-synchronized:

- ▶ Press the electric operating switch or keep it slid forwards for 12 seconds. (Do this only when synchronizing is necessary, not at any other time.)

Have the fault rectified by BMW Service without delay.

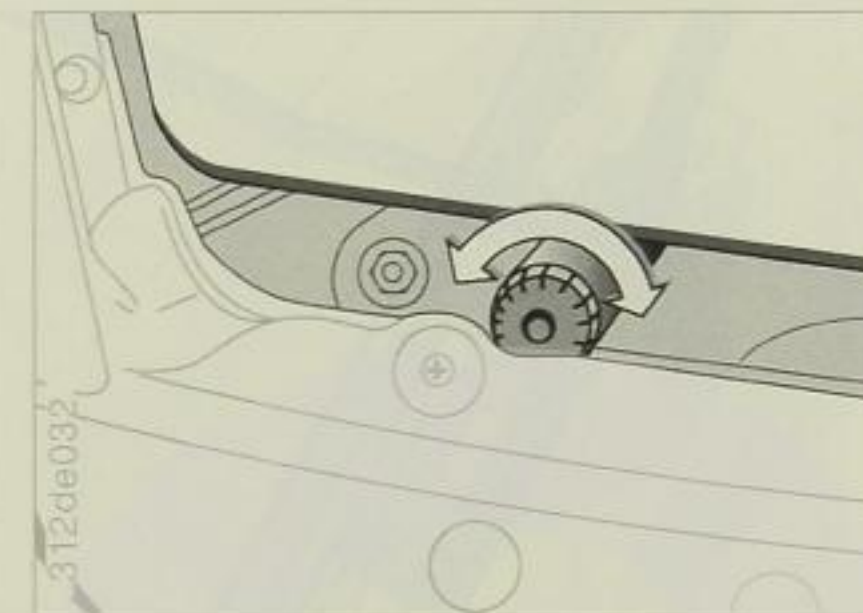

Manual operation

- 1 Open the engine compartment.
- 2 Turn the knurled knob to the left or right until the headlight unit is fully extended or retracted (and no longer moves when the knurled knob is turned several times).

Have the fault rectified by BMW Service without delay.

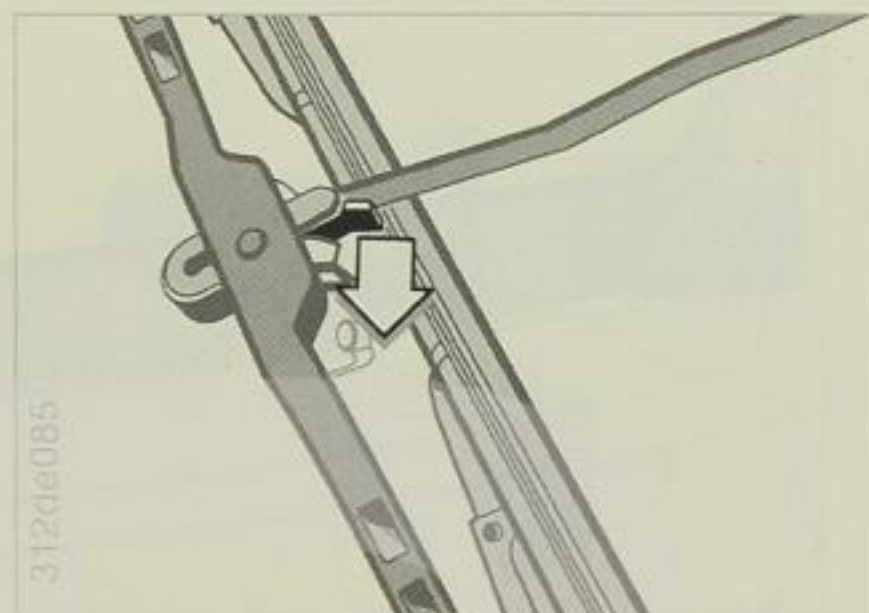

4 Pull the wiper blade towards the wiper arm.

When inserting a new wiper blade, make sure that it engages securely.

- 1 Move the wipers to the fold-out position: Switch on the ignition. Move the wiper control lever to position 1 (intermittent wipe). Switch the ignition off again between wiper movements. The wipers will then move up to an almost vertical position.
- 2 Lift the wiper arm away from the glass and hold it securely.
- 3 For the driver's side wiper, pull the outer spring keeper first and then the inner one (arrow) until the wiper blade is released. There is only one spring keeper on the passenger's side wiper.

Bulbs and lights are crucial safety features of your car. Appropriate care and attention should therefore be taken when handling these components. If you are unfamiliar with such tasks, it is better to entrust them to BMW Service.

 Do not touch the glass of new bulbs with bare fingers. Use a clean cloth, paper tissue or similar, and hold the bulb otherwise only by its base. ◀

A box containing spare bulbs is available from BMW Service.

 Whenever carrying out any work on the car's electrical system, always switch off the consumers in question or disconnect the battery's negative terminal, otherwise there is a risk of causing short-circuits.

Observe any instructions supplied by the bulb manufacturer, to avoid causing injury or damage when changing bulbs. ◀

Pop-up headlights

Outer: Low beam headlights

Centre: Fog lights

Inner: High-beam headlights

Each has one H 1, 55 Watt bulb.

Take off the painted upper section of the pop-up headlight:

- 1 Remove the screw and raise the upper section slightly.
- 2 Push the upper section forward and take it off.

 When attaching the painted upper section of the pop-up headlight, make sure that it is seated correctly – particularly at the front mountings – and that the toggle fastener is properly closed by rotating it through a quarter of a turn. ◀

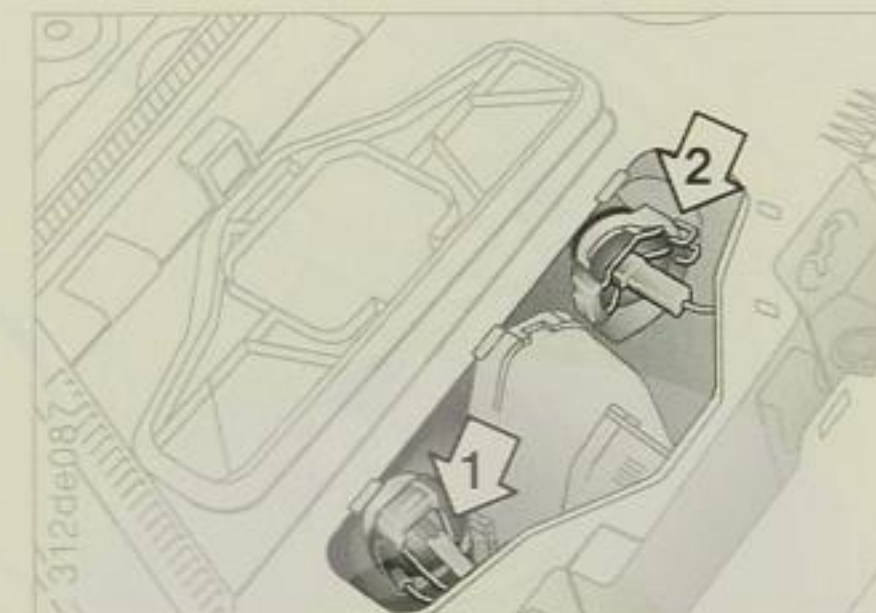
**Low beam headlight (1) and fog light (2)**

 Protective eyewear and gloves should be worn when handling this bulb, if the bulbs are damaged, injury may be caused. ◀

- 1 Pull the flap and take off the cover.
- 2 Pull off the plug.
- 3 Release the spring wire clip.
- 4 Change the bulb.

When attaching the cover again, press it on uniformly all around.

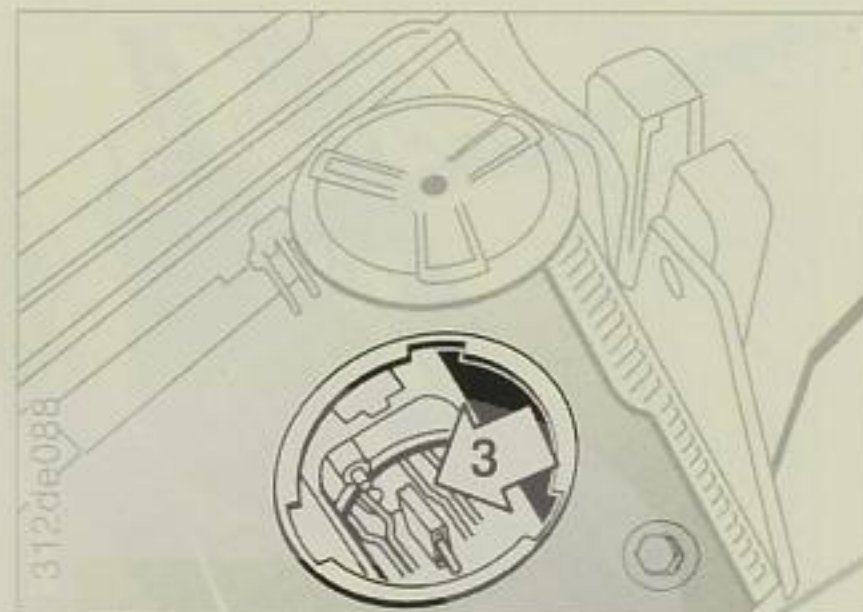
**High beam headlight (3)**

Protective eyewear and gloves should be worn when handling this bulb. If the bulbs are damaged, injury may be caused. ◀

- 1 Turn the cover to the left and take it off (bayonet catch).
- 2 Pull off the plug.
- 3 Press the spring wire clip and disconnect it.
- 4 Change the bulb.

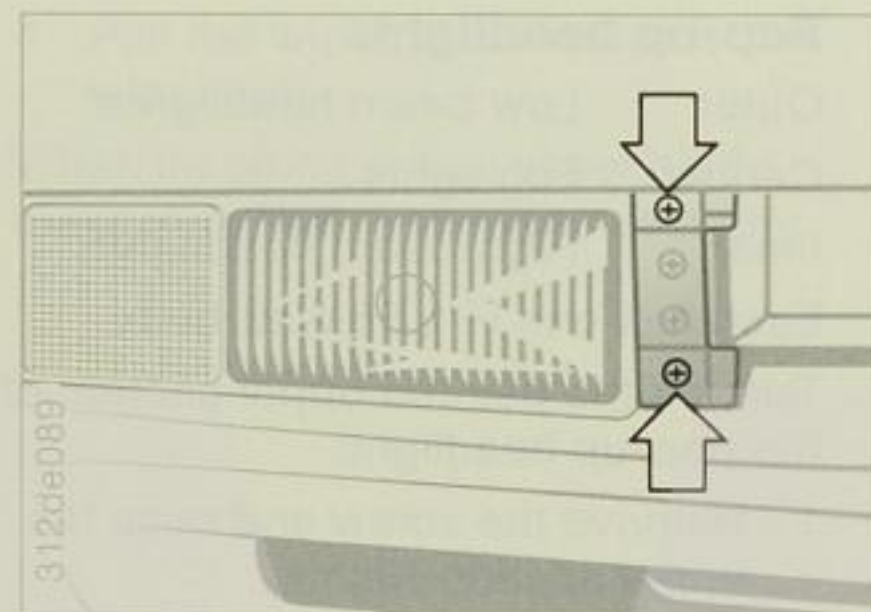
**Lighting strip**

Inner: high beams/headlight flasher
H1, 55 Watt bulb

Centre: side and parking light/daytime driving light*
21/5 Watt bulb

Outer: Left/right flashing turn
21 Watt bulb

Removing:

- 1 Pull the grille out forwards.
- 2 Take out the two Phillips-head screws (arrows).
- 3 Pull the lighting strip out forwards, pivoting it slightly towards the outside of the car and removing it from the guide.

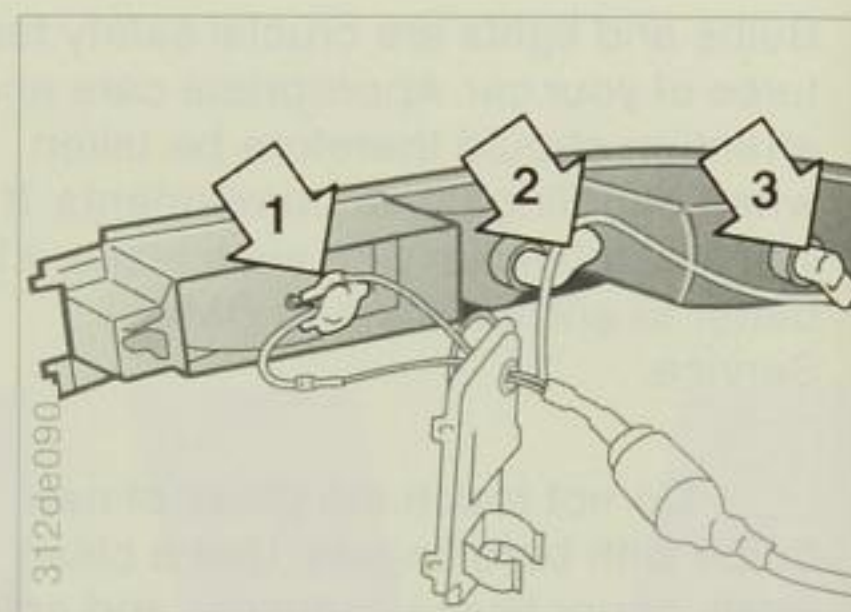
**High beam/headlight flasher (1)**

- 1 Press the cover away from its fastenings with a screwdriver.
- 2 Disconnect the cable.
- 3 Release the spring wire clip and change the bulb.

Side and parking light/daytime driving lights (2)

- 1 Turn the bulb holder to the left and remove it.
- 2 Press the bulb in slightly and turn it to the left to remove.

Flashing turn indicator (3)

- 1 Press the bulb holder in slightly and turn to remove.
- 2 Remove the bulb in the same way.

Side lights

5 Watt bulb

- 1 Press the light unit forward at its rear edge, and remove it to the side.
- 2 Press the bulb in slightly, turn to the left and remove.

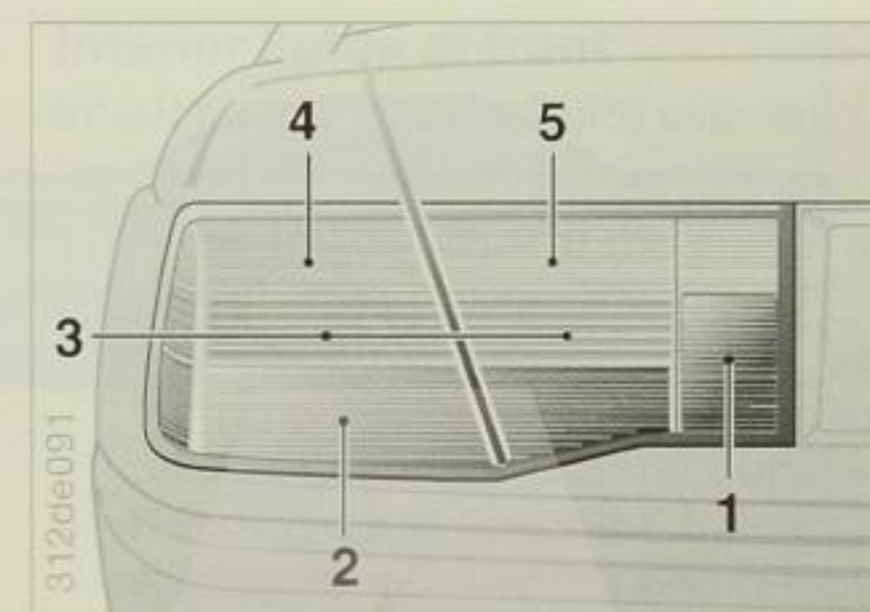
**Rear lights**

- | | |
|------------------------------|--------|
| 1 Rear fog lights | red |
| 2 Brake lights | red |
| 3 Rear lights and reflectors | red |
| 4 Turn indicator | yellow |
| 5 Reversing lights | white |

Rear lights: two 5 Watt bulbs

Other lights: 21 Watt

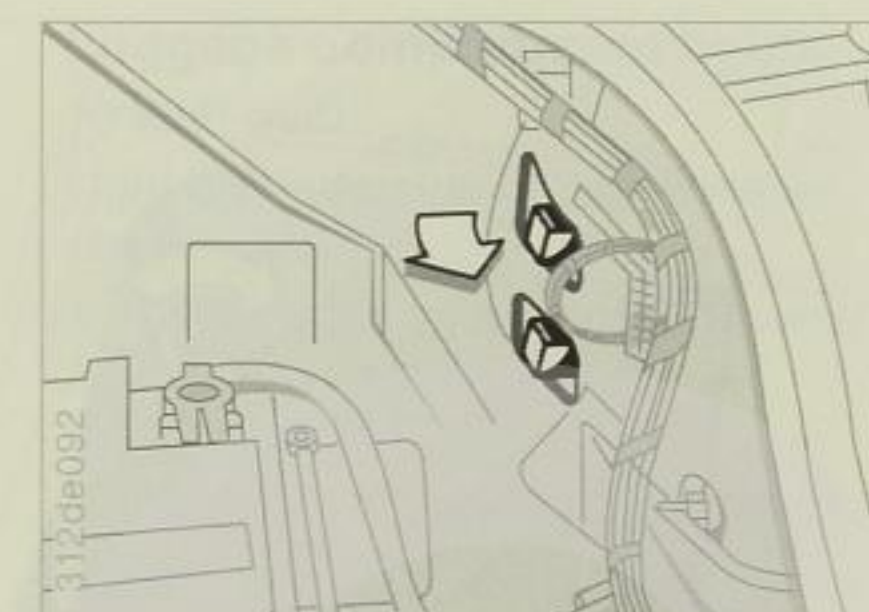
**Lights at side:**

- 1 Take off the trim by holding the pre-formed grip area and pulling.
- 2 Press the appropriate bulb holder in slightly and turn to the left to remove.
- 3 Remove the bulb in the same way.

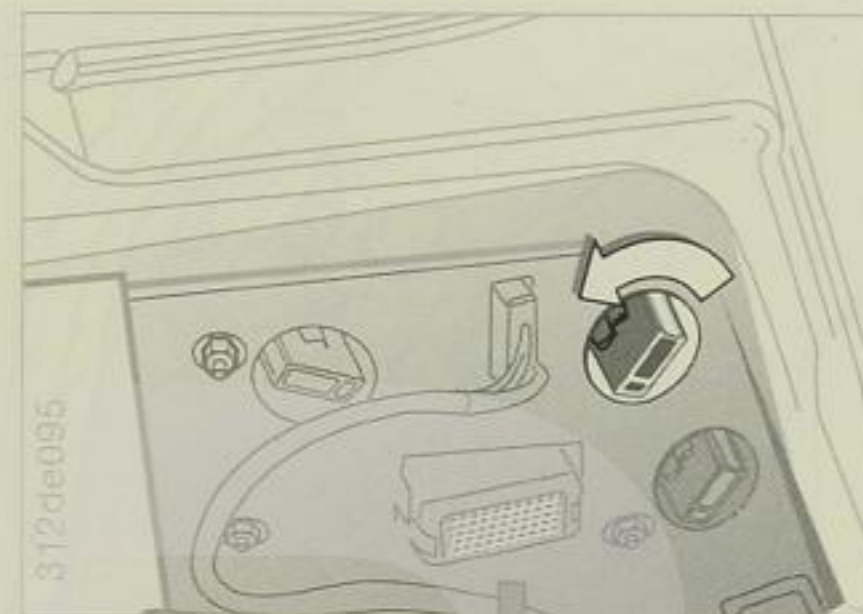

Lights in the luggage compartment lid:

- 1 Raise the trim (quick-release fastener).
- 2 Press the appropriate bulb holder in slightly and turn to the left to remove.
- 3 Remove the bulb in the same way.

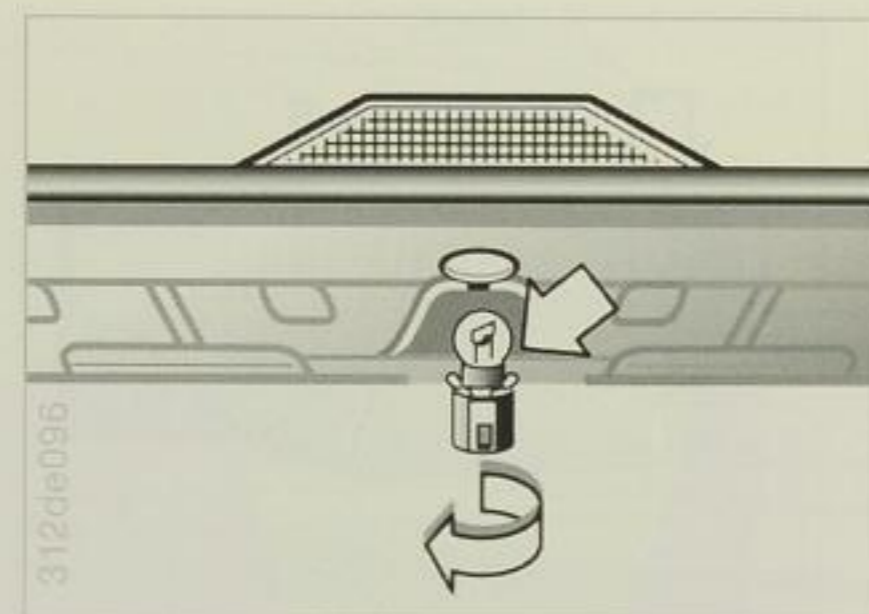

Central brake light

21 Watt bulb

- 1 Open the luggage compartment lid.
- 2 Press the bulb holder slightly, turn to the left and remove.
- 3 Remove the bulb in the same way.

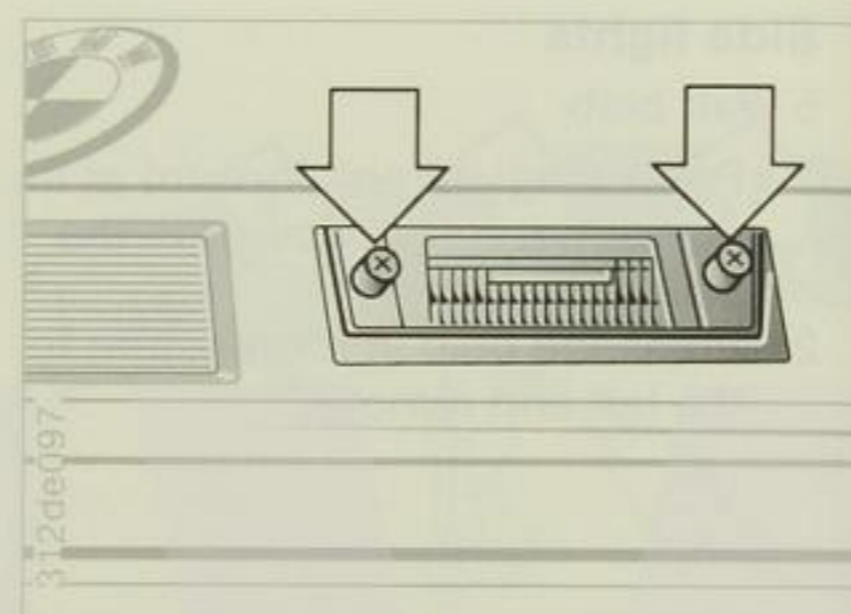

Licence plate lights

5 Watt bulb

- 1 Remove the Phillips-head screws.
- 2 Take off the glass surround with rubber seal.
- 3 Pull the bulb out of the contact tongues.

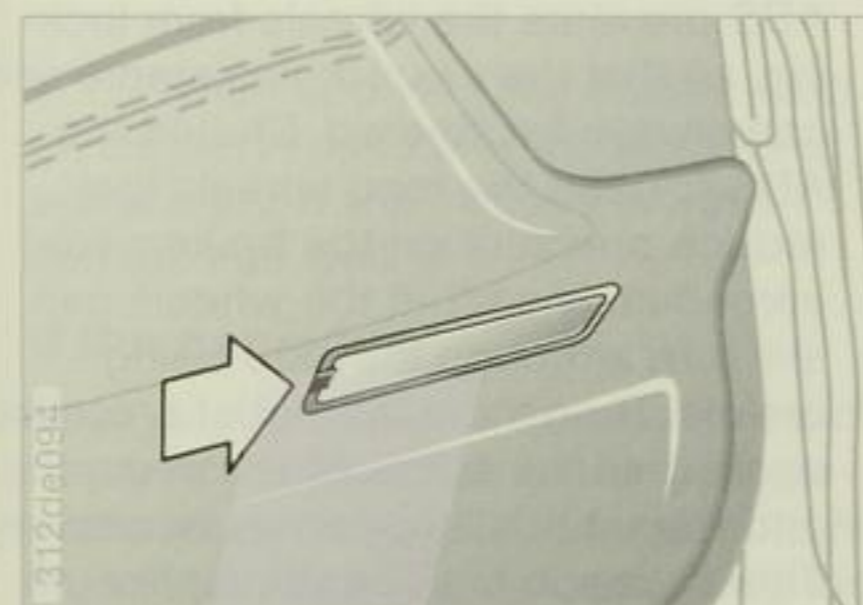

Footwell lights

5 Watt bulb

- 1 Lever the glass carefully out with a screwdriver (arrow).
- 2 Pull the bulb out of the contact tongues.

Interior lights at front

Interior light (10 Watt bulb) with reading lights (10 Watt bulbs)

- 1 Press the light out at the cutout on the left with a screwdriver.
- 2 Interior light: press the plastic lug for the reflector back, swing up the reflector and take out the bulb.
- 3 Reading light: press the bulb in slightly, turn to the left and remove.

Interior lights at rear

10 Watt bulb

- 1 Press the light out at the side recess with a screwdriver.
- 2 Swing up the reflector and take out the bulb.

Luggage compartment lights

10 Watt bulb

Light on underside of rear-window shelf:

- 1 Press it out with a screwdriver at the recess provided.
- 2 Change the bulb.

Lights in the luggage compartment lid:

- 1 Pull off the glass.
- 2 Change the bulb.

Engine compartment light

10 Watt bulb

- 1 Press the black lug on the glass towards the centre with a screwdriver and take off the glass.
- 2 Take out the bulb.

Glove box light

5 Watt bulb

- 1 Press the light out of the lower glove box by applying a screwdriver to its outer edge.
- 2 Change the bulb.

Changeable weather in the winter months not only calls for a suitably cautious style of driving but also for certain measures to be taken on the car, to ensure that it can be driven safely and without problems throughout the winter.

Coolant

Make sure that the required mixing ratio of 50 to 50 parts of water and long-life antifreeze and corrosion inhibitor is present in the system all the year round. It provides protection down to a temperature of app. -37°C. Renew the coolant every 3 years.

Locks

Do not use de-icer, as it has a degreasing effect and will impair the functioning of the locks.

Rubber parts

To prevent the seals from freezing together, treat rubber surfaces with a rubber care product or silicone spray.



Suitable care products are available from BMW Service. ◀

Snow chains*

BMW snow chains*, if used, must only be fitted to both rear wheels (with summer or winter tyres), making sure that the manufacturer's safety instructions are observed. Do not exceed 50km/h (31 mile/h) with snow chains fitted. To enhance traction, it is best to switch off ASC+T/DSC if snow chains are in use; see Page 74.

Moving off

To move away in deep snow or to "rock the car free" it is best to switch off ASC+T/DSC; see Page 74.

Driving on slippery roads

Operate the accelerator pedal sensitively, avoid high engine speeds and shift up to the next higher gear early. On uphill or downhill gradients, select the next lower gear in good time. Maintain a generous distance from the vehicle in front as a safety precaution.

Brakes

Winter road conditions greatly reduce the amount of tyre grip that is available, so that the driver must expect braking distances to be considerably longer than usual in every situation.

ABS prevents the wheels from locking, so that the car remains stable and can always be steered. Should the ABS fail and the road wheels lock, reduce pressure on the brake pedal immediately so that the wheels can still turn although they are being braked. Then increase pedal pressure again until the same situation occurs, and repeat this as often as necessary. This cadence braking principle cuts braking distances and keeps the car steerable, so that you can try to drive round obstructions at reduced braking pressure.



Do not shift to a lower gear as a means of braking the car if the road surface is slippery, or the rear wheels may slide and control of the car may be lost. ABS and ASC+T/DSC cannot prevent this situation, as they do not influence this method of slowing down the car. ◀



When applying the brakes hard on slippery roads or if the amount of surface grip varies widely, always declutch as well. ◀

If the car skids

Take your foot off the accelerator and depress the clutch or move the automatic transmission selector lever to N. Try to steer into the skid and bring the car under control in this way.

Parking

Select the 1st gear or reverse, or move the automatic transmission selector lever to P. If the car is parked on a slope, apply the handbrake as well. To prevent the handbrake linings from sticking to the drums as a result of frost or corrosion, dry the drums by applying the handbrake lightly as the car is coming to halt.



The brake lights do not come on when the handbrake is applied. ◀

When a trailer is towed, the demands on both car and driver are more severe.

A trailer reduces manoeuvrability, the ability to climb hills, acceleration and braking capacity and makes the car handle and corner differently.

The trailer load limit and the permissible nose weight (towbar downthrust) are stated in the "Technical Data", Page 149. The trailer load limit is also recorded in the car's registration document. Consult BMW Service regarding increased trailer weights.

Trailer tow hitch*

The trailer tow hitch* with detachable ball head should be of BMW-approved pattern and, like the trailer turn indicator repeater (which is normally a legal requirement) should be expertly installed by BMW Service.

Keep the detachable ball rod greased to make fitting and removal easier.

Both the comfort and sport suspension settings of your BMW afford optimum safety, ride quality and consistency of handling. They are also perfectly suitable for towing a trailer at up to the standard specified weight, provided that towing is restricted to one vacation period per year or thereabouts, and the driving style is modified to allow for the more severe operating conditions.

If a trailer tow hitch is retrofitted, it is also a good idea to install the trailer-towing suspension. This compensates for the weight of the tow hitch and also ensures optimum road behaviour when the trailer is not being towed. It is also essential if higher trailer weights are to be towed (possible with certain types of trailer).

BMW has not approved any other suspension systems offered by the automotive trade for trailer towing purposes.



If a trailer tow hitch is installed, the self-regenerating action of the rear bumper system may not be able to take effect. ◀

The use of a stabilizing device can be recommended, particularly if the trailer is a heavy one. Information can be obtained from BMW Service.

Nose weight

This is the load exerted downwards by the trailer on the ball head of the tow hitch attached to the rear of the car (it can be determined with the aid of bathroom scales or similar).

In Germany a minimum nose weight of 25 kg (55 lb) is laid down by law.

If the trailer weighs more than 1600kg (3527 lb), the nose weight must be at least 50kg (110 lb).

The nose weight limit should if possible be fully utilized but not exceeded.

The trailer's nose weight is added to the weight of the car, and must not lead to the car's gross weight limit or rear axle load limit being exceeded. The car's payload is reduced by the nose weight if a trailer is being towed, and also by the weight of the trailer tow hitch.

Loading

When loading the trailer, make sure that the weight is kept as low as possible and stowed if possible close to the axle.

A low centre of trailer gravity makes the outfit much more stable and safe to drive.

Do not exceed neither the trailer's gross weight (axle load) or the specified trailer load limit for the car. The smaller value is the limit which should be adhered to.

Before acquiring a trailer it is desirable to obtain from the manufacturer a guaranteed statement of the effective trailer weight and the payload limit.

Electrical system

Higher electrical consumption can be expected if a trailer (caravan) is towed. Run high-consumption items in particular for as short a period as possible in order to avoid draining the battery.

The trailer's rear lights, brake lights and rear fog light are protected by plug-in fuses in the trailer electrical

module. This is behind the left luggage compartment trim. The fuse for the permanently positive line is in the luggage compartment, next to the left battery, in a separate fuse box.

 Always check that the trailer's rear lights are working before starting a journey. ◀

Outside mirrors

The standard outside mirrors may prove inadequate for trailer towing work: the law lays down that the car should be equipped with two outside mirrors with which the rear corners of the trailer can be seen. Mirrors of this kind, including versions with adjustable arms, can be obtained from BMW Service.

Gradients

In the interests of safety and the avoidance of traffic obstructions, the maximum gradient (applicable at sea level) is limited to 12% or, with a higher trailer load (if authorized), 8%.

As altitude above sea level increases, engine power output tends to drop. You should therefore take particular care when driving through the mountains, since the maximum gradient on which the outfit can be started may be lower than usual. Do not make full use of the car's and trailer's gross weight limits.

Downhill gradients

Special care must be taken when descending gradients: always shift down to the next-lower gear before reaching the gradient – if necessary, as low as 1st gear or selector lever position 2 – and drive down the gradient slowly.

Speed limit

The maximum speed limit is 80km/h (app. 50 mile/h) in Germany. Trailer load limits have been chosen to ensure ample driving stability up to this speed. Although higher speeds may be permitted in other countries, you are recommended not to drive faster for safety reasons.

If the trailer begins to swing from side to side, the outfit can only be stabilized by braking immediately.

Tyre pressures

Check the car's and the trailer's tyre pressures most carefully. Comply with the trailer manufacturer's tyre pressure instructions.

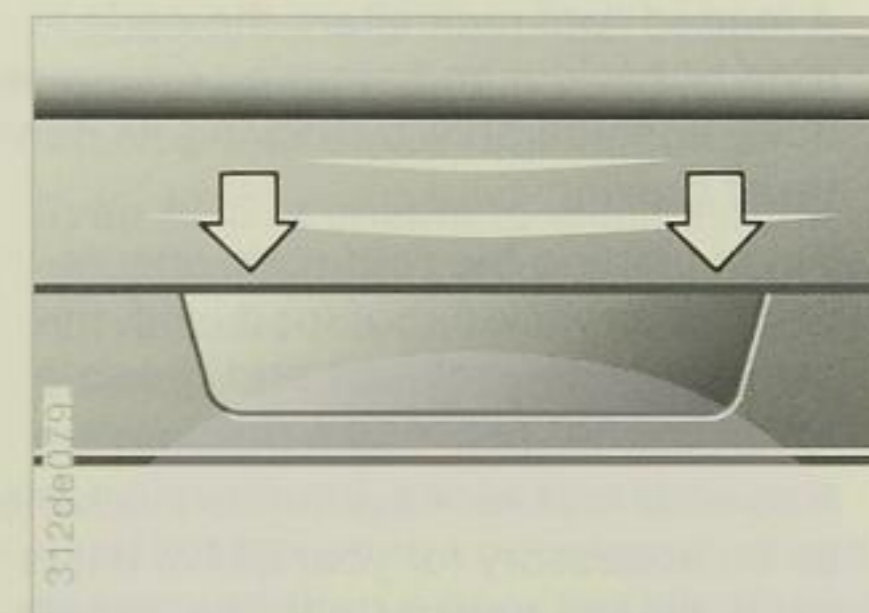

Cover flap

Take hold of the cover flap for the trailer tow hitch at the top cutout, pull to the rear and down (if necessary, use a screwdriver to unclip it) and remove it from the lower guide.

For attaching and removing the ball head, please refer to the separate instructions.

To attach the cover flap, first locate the groove at the bottom in the guide and then press the flap into place at the top.

A loaded roof rack alters the car's road behaviour and steering response quite considerably, by moving its centre of gravity.

When loading the roof rack, ensure that the specified roof load limit, the car's gross weight limit and the axle loads are not exceeded.

A special roof rack system is available as an accessory for your BMW. If it is used, please comply with the installation instructions supplied.

The roof load must be uniformly distributed and should not be too large in area. Heavy items of luggage should always be placed at the bottom.

Correct, secure loading of the roof rack will prevent items from shifting or falling off during the journey, and thus endangering following traffic.

Drive smoothly when there is a load on the roof: avoid violent acceleration, braking or cornering.

The roof load increases the car's surface area exposed to the wind, so that fuel consumption will be higher and the loads on the roof structure of the car more severe.

Driving on the right/left

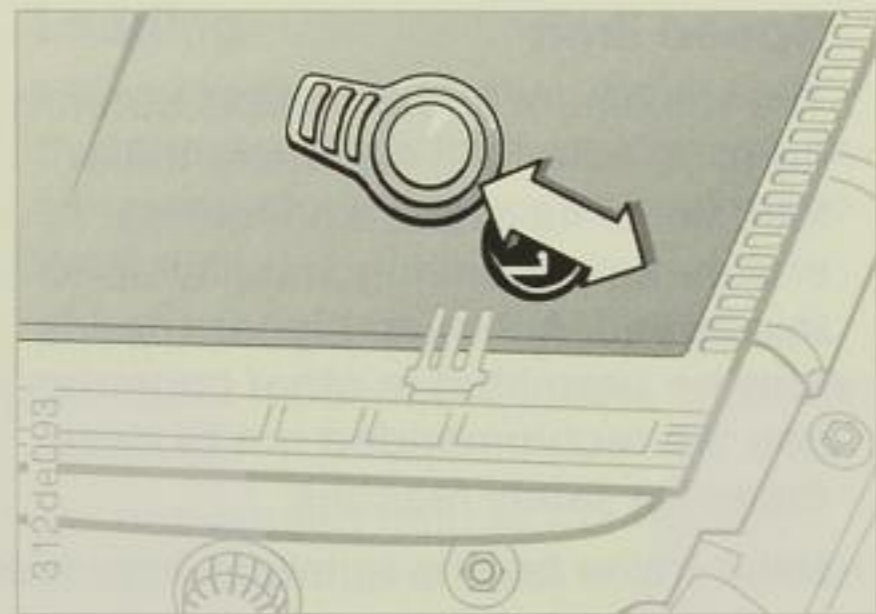

When entering a country in which the traffic drives on the other side of the road:

- 1 Take off the painted upper section of the pop-up headlight: turn the toggle fastener through a quarter of a turn and lift the upper section slightly. Push the upper section forwards and take it off.
- 2 Take out the plug.
- 3 For driving on the left: move the lever to the left. For driving on the right: move the lever to the right.



When attaching the painted upper section of the pop-up headlights, make sure that it is correctly seated, particularly at the front mounting points, and that the toggle fastener is properly secured by rotating through a quarter of a turn. ◀

Licensing for use abroad

Cars are always supplied to conform with the registration laws of the country in which they are intended for use.

If the owner moves to another country, it is important to check beforehand that import regulations and vehicle licensing laws do not make it too difficult to import the car.

You can obtain information in Germany by telephoning 089-382-0 and stating the model, vehicle identification number and date first registered.

In other countries, please consult BMW Service or the importer.

ABS

The anti-lock brake system (ABS) prevents the wheels from locking and thus enhances active safety. Locked wheels are dangerous, because the front wheels cannot then be steered and the rear wheels may slide sideways and cause the car to spin or slide off the road.

With ABS in action, the car achieves the shortest possible braking distances for the prevailing conditions (straight-line braking or cornering, on asphalt, ice, wet roads etc.).

ABS is capable of satisfying two fundamental requirements whenever the brakes are applied:

- ▷ Assured driving stability on varying road surfaces (e.g. asphalt, concrete, mud, wet roads, snow and ice).
- ▷ Assured steerability and manoeuvrability in these conditions.

However, certain important considerations must be borne in mind in connection with these requirements:

Even ABS is unable to eliminate the effects of natural physical laws. It cannot absolve the driver from the consequences of braking too late, maintaining insufficient space from vehicles ahead, exceeding the limits of adhesion when cornering at speed or encountering a poor stretch of road where aquaplaning occurs. Avoiding such situations remains the driver's responsibility.

Although ABS enhances active driving safety, this should not be regarded as an invitation to take correspondingly severe risks.

Driving with ABS

After the engine has been started, the yellow ABS warning light on the instrument panel goes out.

The ABS system itself becomes operational above a road speed of app. 8km/h (5 mile/h). If the car's speed drops below app. 3km/h (2 mile/h), the ABS ceases to take effect, so that in the very last phase of a brake application the wheels could theoretically tend to lock, but in practice this is not critical.

The ABS regulation cycle takes place within fractions of a second. The brake pedal pulsates to warn the driver that the ABS is active and therefore that the car is reaching the adhesion limit. In addition a chattering noise is heard – caused by the pressure regulating action – to remind the driver that the tyres' grip on the road is decreasing (slippery surfaces) and that the car's speed may therefore need to be reduced accordingly.



If the road surface consists of loose material on a firm underlayer, for instance stone chippings or powdery snow, the car's braking distance may sometimes actually be longer than if the wheels were to lock.

The same applies if snow chains are fitted. However, the advantages of greater stability and the ability to steer while braking are still available to the driver.

To ensure that the ABS system always remains fully operational it must never be modified in any way, and all work on the ABS should be entrusted only to skilled, authorized personnel. ◀

ABS may not function at maximum efficiency if tyres of different sizes are fitted (e.g. winter tyres/spare wheel); in such cases, revert to the correct wheels and tyres as soon as possible.

Any malfunction is shown by the yellow ABS warning light on the instrument panel coming on. The brake system continues to work normally as on a vehicle without ABS, but should none the less be examined without delay by BMW Service. Additional faults to the brake system could otherwise occur without being readily apparent.

Active Rear Axle Kinematics (ARK)*

Unforeseen driving situations often call upon the driver to react swiftly by taking corrective steering action. The vehicle may be felt to respond in a surprising or unpredictable manner as a result. The ARK system modifies or prevents such reactions.

At a speed of app. 40km/h (app. 25 mile/h) or above, the ARK is activated with every movement of the steering wheel; it modifies the rear wheel lock angle and repositions the rear wheels ideally to suit the driving situation.

The optimum rear-wheel angle is calculated from the steering wheel's momentary lock angle and the vehicle's road speed; the wheel angles are then adjusted by the electro-hydraulic control circuit. As a result of the vehicle's increased stability, it responds more predictably to steering wheel movements.

However, these improved driving characteristics cannot overcome the basic laws of physics to which a moving vehicle is subject. It remains the driver's responsibility not to initiate excessive steering-wheel movements or go beyond safe cornering speeds.

Each time the engine is started, the ARK control unit runs through a self-check sequence. In the event of a system fault, which will be indicated by the telltale light in the instrument cluster and the display R/AXLE FAILSAFE PROG in the MID, the lock angle of the rear wheels will no longer be adjusted. The wheels will normally remain in the straight-ahead position, with the result that the vehicle can be driven normally. In exceptional cases, the wheels could remain locked at an angle. If this occurs, the steering wheel will be slightly offset to compensate when the vehicle is travelling in a straight line. Here again, the vehicle can still be driven normally. Note, however, that in this situation the rear wheels will run slightly off-track and the vehicle will occupy marginally more road space across its width as a result.

Minor, temporary faults can be rectified by starting the engine again to initiate the system's self-check. If the telltale light does not go out even after the engine is restarted, contact BMW Service to have the system repaired.

Disc brakes offer maximum braking efficiency, responsive control of braking force and the ability to resist severe loads.

If the car is not driven very far, is parked out of use for lengthy periods or is mostly driven very gently, corrosion of the brake discs and contamination of the pads may unfortunately be encouraged, since the minimum pressures between pad and disc which are needed to obtain an automatic cleaning action are seldom reached.

When the brakes are applied, corroded discs tend to judder, and even lengthy brake applications usually fail to eliminate this effect entirely.

 Use only brake pads approved by BMW, or else the car's operating permit will be invalidated. ◀

Driving hints

In damp weather or heavy rain it is advisable to apply the brakes with light pedal pressure every few kilometres. When doing so, make sure that no other road-user is endangered. This will generate sufficient heat to dry out the discs and pads.

It is a well-known fact that the best braking effect is obtained not with locked wheels but with wheels that are still just rotating. ABS maintains this state of affairs automatically. If an ABS malfunction occurs, the driver should adopt the cadence braking principle if possible (see Page 122).

To avoid any risk of brake fade when descending long or steep hills, select the gear which calls for a minimum amount of braking (or shift the automatic transmission down to an equivalent speed stage).

Engine braking can be enhanced by shifting to a lower gear, if necessary as far as first gear or selector lever position 2.

If engine braking alone is insufficient, do not apply the brakes for too long with only slight or moderate force. Instead, it is better to brake the car quite hard (providing that the road behind you is clear) so that your speed is reduced noticeably, and to repeat this process at brief intervals as necessary. The cooling-down phases between these brake applications should avoid overheating and maintain full braking efficiency.

 Never hold the clutch pedal down, move the gearbox or automatic transmission into neutral or – an even more dangerous practice – switch off the engine while the car is in motion. Engine braking is lost in neutral, and there is no brake servo effect when the engine is stopped. Make sure that the full travel of the brake, clutch and accelerator pedals is never obstructed by the floor carpet, loose mats or any other items. ◀

Information for your safety

The factory-approved radial-ply (braced tread) tyres have been chosen to match your car's performance and to ensure driving safety and the desired standard of ride comfort.

The condition of the tyres and maintenance of the specified tyre pressures not only influence tyre life but also road safety to a very considerable extent.

Incorrect tyre pressures are often a cause of tyre problems. They also have a considerable effect on the roadholding of your BMW.

 Check tyre pressures regularly (including the spare wheel) before starting a long journey and in any event at least twice a month. Failing this, incorrect tyre pressures could render the car unstable when driven or cause tyre damage which could result in an accident. ◀

Inspect tyres frequently for damage, the presence of foreign bodies, unusual wear and sufficient tread depth.

Tread depth should not be less than 3mm (app. 0.12 in), even if the minimum legal requirement is only 1.6mm (app. 0.06 in). You are recommended to replace tyres when the tread depth is down to 3 mm, or else the risk of aquaplaning on even shallow water will be increased.

We recommend fitting new tyres when the treads are 3mm deep. If they remain in use, wear indicators in the base of the tread appear at a tread depth of 1.6mm as a warning that the legal wear limit (valid throughout Europe since 01.01.1992) has been reached.

When parking the car or driving over loading ramps, workshop hoists etc., make sure that the side walls of the tyres are not damaged by violent contact with obstructions.

 Never try to drive any further if a tyre goes flat. If air pressure is lost from a tyre, this seriously affects the car's handling and braking, and could cause the driver to lose control. Avoid overloading the car, as this

could cause the tyres' load capacity limit to be exceeded. Overheating can also occur, and the tyre can suffer internal damage at a relatively rapid rate. This could lead to sudden pressure loss.

Unusual vibration while the car is being driven could indicate a tyre fault or some other defect on your car. The same applies to any other abnormal road behaviour, such as pulling severely to the right or left. In such cases, reduce speed immediately. Proceed carefully to the nearest BMW Service station or tyre dealer, or have the car towed there so that it can be checked or its tyres inspected.

All forms of tyre damage (which could in the worst case lead to sudden and total loss of pressure) represent a risk of serious or even fatal injury to the car's occupants and to all other road users. ◀

To maintain the car's good road behaviour, always fit tyres of the same make and tread pattern to all wheels.



Do not use retreaded tyres on this car, as they could impair its road behaviour and safety. Their carcasses may differ in internal construction or have aged sufficiently to cast doubt on their durability. ◀

Interchanging wheels and tyres

Tread wear patterns vary between the front and rear wheels, according to the individual conditions in which the car is operated. In the interests of safety and the best possible vehicle behaviour, you are recommended not to adopt the practice of interchanging the wheels.

If you wish to interchange the wheels for reasons of operating cost, remember that the expense incurred in interchanging the wheels also has to be taken into account when assessing whether it is worth trying to extend the tyres' operating life in this way. BMW Service can advise you.

If you do decide to interchange the wheels, please take the following precautions:

Interchange the wheels on the same side of the car only (though the spare wheel can be included if desired).

Remember that braking efficiency and tyre grip may be adversely affected.

If tyres are interchanged in this way, the process should take place at frequent intervals (max. 5000km/3000 miles).

Always check tyre pressures after fitting, and adjust as necessary.

Spare tyres more than 6 years old should be reserved for genuine emergencies, that is to say if the car's mobility cannot otherwise be maintained. New tyres should be fitted in their place as soon as possible, and they should no longer be brought into regular service when new tyres are fitted.

A tyre's date of manufacture is shown as part of the inscription on the tyre wall:
DOT ... 413 means for instance the 41st week of 1993

Choosing the correct tyres

Wheels and tyres

Use only BMW-approved tyres. In view of the car's maximum speed, certain makes and sizes are compulsory. Details can be obtained from BMW Service. Comply in addition with any relevant national regulations.

The correct choice is made easier if the meaning of the tyre markings is understood. For radial-ply tyres, the following markings apply:

e.g. 235/50 R 16 95 W

Nominal width in millimetres
Aspect ratio in %
Code letter for radial ply
Rim diameter in inches
Load capacity figure (not on ZR tyres)
Speed code letter (ahead of the R on ZR tyres)

The speed code letter indicates the maximum permissible speed at which the tyre is to be operated.

On summer tyres:

S = up to 180km/h (app. 112 mile/h)
T = up to 190km/h (app. 118 mile/h)
H = up to 210km/h (app. 130 mile/h)
V = up to 240km/h (app. 149 mile/h)
ZR = over 240km/h (app. 149 mile/h)
W = up to 270km/h (app. 167 mile/h)

On winter tyres:

Q M+S = up to 160km/h (app. 99 mile/h)
T M+S = up to 190km/h (app. 118 mile/h)
H M+S = up to 210km/h (app. 130 mile/h)

Marks on light alloy wheels:

Rim width in inches 9½ J x 18 AH 2
Rim shoulder contour code letter
Symbol for well-base rim
Rim diameter in inches
Asymmetric **H**ump on **2** rim shoulders

Tyre valves should be protected against dirt entering by attaching screw caps. Dirt in the tyre valve can often lead to a gradual loss of air pressure.

If winter tyres – (M&S radial-ply) – are fitted, the same make and tread pattern should be used on all four wheels (and preferably on the spare wheel as well) in the interests of good directional stability and steering response.

Fit only winter tyres approved by BMW. BMW Service will gladly advise you on the correct winter tyres for the conditions in which your car has to operate.

Always note and comply with the maximum speed limit for your winter tyres.

In Germany: a suitable warning label according to § 36 StVZO has to be attached within the driver's field of view if the car's top speed is higher.

Tyre dealers and BMW Service points can supply these labels.

Below a tread depth of 4 mm (app. 0.16 in), winter tyres become noticeably less suitable for winter driving conditions and should therefore be replaced without undue delay for safety reasons.

Note the specified tyre pressures and have the wheels with tyres balanced each time a tyre or wheel is changed.

 Always note and comply with the maximum speed limit for your winter tyres.

Lack of expert knowledge or incorrect handling of tyres can cause damage and lead to accidents.

All work on tyres should therefore be carried out only by experts. BMW Service will gladly assist you. ◀

Store wheels and tyres in a cool, dry and preferably dark place when not in use. Protect tyres against contamination from oil, grease and fuel.

Note the tyre and wheel data in the car's official documents. If sizes not approved by the manufacturer are fitted, an entry in the car's documents may be necessary.

Fine-link BMW snow chains* can be fitted at the rear with either summer (not on 850CSi) or winter tyres in use, but only to both wheels. Always observe the manufacturer's safety recommendations when fitting.

Radial-ply tyres (tubeless)	Pressed-steel (wheel)	Alloy wheel	Wheel offset mm
BMW 840Ci, BMW 850Ci			
225/55 R 16 95 Q/T/H M+S	–	7 1/2 J x 16 H2	15
235/50 R 16 95 W	–	7 1/2 J x 16 H2	15
235/50 R 16 95 Q/T/H M+S	–	7 1/2 J x 16 H2	15
235/45 R 17 93 W	–	8 J x 17 H2	10
235/45 ZR 17	–	8 J x 17 H2	10
235/45 R 17 93 Q/T/H M+S	–	8 J x 17 H2	10
265/40 R 17 96 W*	–	9 J x 17 H2	19
265/40 ZR 17**	–	9 J x 17 H2	19
BMW 850CSi			
235/45 ZR 17	–	8 J x 17 AH2	10
235/45 R 17 93 Q/T/H M+S	–	8 J x 17 AH2	10
265/40 ZR 17**	–	9 J x 17 AH2	19
245/40 ZR 18***	–	8 J x 18 AH2	13
285/35 ZR 18***	–	9 1/2 J x 18 AH2	25

* Only permissible as mixed set with 235/45 R 17 93 W at front. Snow chains cannot be fitted.

** Only permissible as mixed set with 235/45 ZR 17 at front. Snow chains cannot be fitted.

*** Only permissible as mixed set with 245/40 ZR 18 at front. Snow chains cannot be fitted.

Any BMW Service point can provide you with information as to the practical value of an intended modification and whether it is legally permissible and approved by the manufacturer. Enquiries should be accompanied by the vehicle identification number and, if relevant, the engine number.

Light-emitting diodes (LED)

Some of the controls, displays and other interior equipment of your car includes light-emitting diodes behind suitable covers as a light source. These LEDs resemble conventional lasers and are classified by law as Class 1 light-emitting diodes.



Do not remove the cover or expose the eyes directly to the unfiltered light source for several hours at a time, as this could cause irritation to the iris. ◀

The BMW Maintenance System 138

Care of the care 139

Laying the car up out of use 144

Important facts in brief

Controls

Operating hints

Care and maintenance

Technical data

Index

The BMW Maintenance System has been planned to ensure that the car always remains safe for the road and reliable, without any unnecessary expense for the customer. Regular and correct maintenance also helps to maintain the car's resale value.

Service Interval indicator

Advanced technologies have been adopted as a means of computing maintenance requirements, which are then shown on the Service Interval indicator. Whereas conventional maintenance schedules are based entirely on fixed distance intervals, the BMW maintenance system takes the car's operating conditions into account, bearing in mind that one kilometre is not the same as another: 100000km completed exclusively in the form of short journeys cannot be considered the same as 100000km made up of long main-road journeys only.

The BMW maintenance system based on actual operating conditions consists of an Oil Service and Inspections I and II.

For further information on maintenance points and the scope of maintenance work, please refer to the car's Service Booklet.

The principle of determining maintenance intervals according to load effectively covers all the operating conditions to which the car is likely to be exposed. However, if the car is very little used – that is to say if it covers distinctly

fewer than 10000 kilometres (approx. 6,000 miles) a year – an annual engine oil change should be carried out, since the engine oil ages even if not subjected to mechanical loads.

Service Booklet

It may also be worthwhile having the body checked for stone-impact damage at the same time, in order to safeguard against corrosion.

Please make sure that the maintenance work is confirmed in the car's Service Booklet. These entries are evidence that your car has been serviced regularly and correctly, and are also the basis of any warranty claims.

Paintwork

The car's body is protected by multiple coats of paint against corrosion. Note that body cavities have been protected in addition to cathaphoretic dip coating by applying specially developed materials which have been subjected to prolonged testing.

The complete underside of the body is sprayed with a resilient PVC coating and then fully protected by a wax-based underseal.

Always remember that regular care of your car will go a long way towards maintaining not only its safe condition but also its resale value.

Environmental influences which differ from one region to another can affect your car's paintwork; the nature and frequency of the care you give the car should be governed by these factors.

Road dirt, tar stains, dead insects, bird droppings (powerful alkaline action) and also resin and pollen from trees and bushes all contain substances which could damage the paint surface after a period of time (stains, blistering, caustic burns, peeling off of the top paint layer).

In industrial areas, airborne fly ash, lime, oily soot, acid rain or sulphur dioxide as well as other impurities in the air are bound to attack the paintwork if not cleaned with sufficient regularity, though in most cases only the horizontal panel surfaces are affected.

In coastal regions the high salt content and humidity of the air encourages more rapid corrosion.

In the case of mechanical loads caused by sand, road salt, stone chippings or similar, the paint surface may be broken and corrosion may then be able to develop under the paint, and spread out from the damaged areas.

Awareness of these negative environmental effects on the paintwork has stimulated motor vehicle and paint manufacturers to increase the durability and strength of their paints wherever possible.

BMW Service stations supply factory-tested Original BMW car care products for all general work of this kind which you intend to carry out yourself.

Care of paintwork

Washing the car once a week will prevent harmful substances from causing long-term damage to the paint finish, particularly if the car is parked or driven in regions where atmospheric pollution levels are high or natural impurities occur in the air (sap from trees, pollen).

Please remove particularly aggressive substances immediately, or else the paint may be attacked or discoloured. Such substances include spilled fuel, oil, grease, brake fluid or bird droppings.

After washing, residual dirt will be clearly visible. It should be removed without delay, using cleaning-grade benzene or white spirit on a clean cloth or wadding. Remove tar stains with a suitable tar remover, but do not apply this product to lenses and headlight covers. Finally, apply a paint preserving product to the treated areas.



Cleaning and care products can be obtained from BMW Service. ◀

Car wash

A new BMW can be put through an automatic car wash, or washed by hand, immediately.

However, do not wash the car in the sun, immediately after it has stood in the sun or when the engine compartment lid is still warm, in order to avoid blotches on the paintwork.

If an automatic car wash is used, make sure that

- ▷ add-on body elements such as spoilers cannot be damaged. If in doubt, consult the car wash operator first.
- ▷ The brush pressure must be as low as possible, and the car wash should operate with ample rinsing water.

Before washing the car, it is best to soak and wash off dead insects.



If a steam jet or high-pressure washer is used, make sure that it is held sufficiently far away from the car's panel surfaces. If it is held too near or if the pressure is excessive, the bodywork could either become damaged immediately or eventual damage prompted. In addition, water could penetrate various components on the car and cause long-term damage or failure. ◀

Body areas not always reached effectively by the car wash brushes, such as door sills, door seams and panel gaps, should be cleaned by hand.

During the winter months in particular, wash the car more frequently. Severe dirt deposits and road salt are difficult to remove and tend to damage the paintwork if not attended to promptly.



After the car has been washed, the brakes may be damp and therefore less efficient. Dry the brake discs by applying them briefly as soon as the car is driven. ◀

After washing, residual dirt will be clearly visible. It should be removed without delay, using cleaning-grade benzene or white spirit on a clean cloth or wadding. Clean off tar stains with a tar remover.

Finally, apply a paint protection product to the treated areas.

Protecting the paintwork

Polish the paintwork only with products containing Carnauba or synthetic waxes.

A sure sign that the paintwork needs protective treatment is when water no longer forms large droplets and rolls off the surface. Depending on how and where the car is used, this can be the case after only 3 to 4 months.

Remove care product residues and silicone from the windscreen with glass cleaner.



Cleaning and care products can be obtained from BMW Service. ◀

Touching in paint damage

Minor paint damage can be touched in with a BMW paint spray can or a BMW paint pencil, or repaired with BMW paint film.

Your car's paint colour is stated on a label close to its type plate, and also on the first page of the Service Booklet.

Scratches and damage caused by flying stones must be repaired immediately, to prevent rust from forming.

If any areas of the body have already started to rust as a result of paint damage, clean them with a wire brush and apply a rust inhibitor or converter (protect the eyes and skin.) Allow to act for several minutes, then rinse off with water and allow the treated area to dry thoroughly. Apply primer and allow this to dry thoroughly, then apply the top coat. After a few days, polish the repainted areas and apply paint protection.

More widespread paint damage should be entrusted to BMW Service, which can repair it expertly in accordance with the manufacturer's specifications and using Original BMW paint materials.

Care of special components

Light alloy wheels should be treated with wheel cleaner, but do not use products which are of an aggressive nature, contain acid or abrasives or are strongly alkaline. Steam jets used to clean the wheels should not reach a temperature of more than 60 °C. (In all cases, comply with the manufacturer's instructions.)

The insides of the windows and the mirror glasses can be cleaned with a glass cleaner which leaves no smears. Never clean mirror glasses with products containing quartz or similar abrasive polishing pastes.

Plastic parts, imitation leather upholstery or trim, roof linings, light glasses and parts sprayed with matt black paint must be cleaned with water, to which a car shampoo can be added if required. Do not allow the roof lining to become wet right through. If necessary, treat plastic parts with a plastics cleaner. Never use solvents such as nitro thinners, cold cleansers, fuel or similar.

Apart from water, treat rubber parts only with rubber care products or silicone spray.

Clean the wiper blades with soapy water. They should be renewed twice a year (before and after the winter season).

Seat belts should only be cleaned with mild soap suds (without removing them from the car). Do not dry-clean or use chemical products, or the fabric may be weakened.

Never allow automatic seat belts to retract unless they are dry. Dirt on the seat belts can interfere with the action of the reel and represent a safety hazard.



BMW Service can supply suitable car-care products. ◀

Floor carpets and mats* can be treated with a car interior cleaner if very dirty. The floor mats can be taken out of the car to enable the interior to be cleaned more thoroughly.

Care of upholstery

The pressure areas which occur when cloth seats are in regular daily use can be restored by brushing against the pile direction with a slightly moistened brush.

The tendency of the pile to lie in a particular direction on velour upholstery is not a quality defect and, just as on home textiles or clothing, cannot be avoided.

Remove fluff from cloth upholstery and rubbed-in threads or scraps of cloth or suede with a suitable fluff roller or burr brush. A cleaning glove is available to remove particularly obstinate fluff. Stains and fairly large areas of dirt should be cleaned off without delay, using lukewarm water and an interior cleaner, stain remover or cleaning-grade benzene. Brush the fabric afterwards to restore its appearance.

Cover the seats if exposed to hot summer sun for lengthy periods, so that the upholstery does not fade.

The build-up of a static electrical charge on the seats, particularly if atmospheric humidity is low, can give the occupants an unpleasant electric shock if they touch metal parts of the car after leaving it. Although this is not dangerous in any way, it can be avoided by touching a bare or polished metal part of the car while getting out.

If necessary, anti-static products can be used to eliminate this effect to a large extent.



BMW Service can supply suitable car-care products. ◀

Care of leather

The leather* used by BMW is a natural product of the highest quality, processed by the very latest methods, and will remain in good condition for many years if correctly treated.

Since leather is an absolutely natural product, its characteristics and certain restrictions on its use and special care precautions must be noted.

Regular cleaning and care are needed, since dust and dirt, for instance from the roads, collect in pores and creases, cause severe abrasion and can lead to the leather surface becoming prematurely brittle.

If exposed to strong sunlight when the car is parked for a lengthy period, leather-upholstered seats should be covered or the windows blanked off to prevent fading.

To clean, slightly moisten a cotton or woollen cloth with water and rub the leather surface gently without allowing moisture to collect in the seams. Dry and rub down with a clean, soft cloth.

Leather that has become very dirty can be cleaned with a mild detergent containing no brighteners (2 tablespoons in 1 litre of water). Dab grease or oil stains carefully with cleaning-grade benzene, without rubbing them hard.

After cleaning, leather surfaces should be treated with a suitable leather care product* to protect them and prevent the build-up of a static electrical charge. Shake well and apply a thin coating with a soft cloth. Allow to dry and rub with a clean, soft cloth.

In normal conditions, repeat this treatment every six months.



BMW Service can supply suitable car-care products. ◀



Keep cleaning products out of the reach of children. Many products are toxic or flammable, and therefore hazardous in use. Before using any such product, study and comply with the instructions supplied with it, and note any warnings or precautions stated on the pack. When cleaning the car's interior, always open a door or window. Never use products or solvents not specified for cleaning the car. ◀

Ask your BMW Service point for advice on the work needed if you plan to lay the car up out of use for more than three months.

Important facts in brief

Controls

Operating hints

Care and maintenance

Technical data

Index

- Engine data 146
- Fuel consumption, carbon dioxide (CO₂) emissions 147
- Dimensions 148
- Weights 149
- Performance 150
- Filling capacities 151
- Electrical system 152
- V-belts 152

		BMW 840Ci	BMW 850Ci	BMW850CSi
Displacement	cm ³	4398	5379	5576
Number of cylinders		8	12	12
Max. output	kW	210	240	280
	bhp	286	326	380
- at engine speed	1/min	5700	5000	5300
Max. torque	Nm	420	490	550
- at engine speed	1/min	3900	3900	4000
Compression ratio	e	10.0	10.0	9.8
Bore/stroke	mm	82.7/92	79/85	80/86
Mixture preparation		Digital Motor Electronics		

		BMW 840Ci	BMW 850Ci	BMW 850CSi
		6-speed gearbox	Autom. transm.	Autom. transm.
		6-speed gearbox	Autom. transm.	6-speed gearbox
Town	litres/100 km (Imp. mile/gal)	19.7 (14.3)	20.9 (13.5)	21.1 (13.4)
Country	litres/100 km (Imp. mile/gal)	9.3 (30.4)	9.7 (29.1)	9.9 (28.5)
Total	litres/100 km (Imp. mile/gal)	13.1 (21.6)	13.8 (20.5)	14.0 (20.2)
CO ₂ emissions	grammes/km	313	329	333

Fuel consumption is determined in accordance with standardised test procedures (93/116/EU). It is by no means identical with the car's average consumption, which depends on a variety of factors such as driving style, load, road condition, traffic density and flow, the weather, tyre pressures etc. Engine power output and the car's performance are measured in accordance with conditions laid down in 80/1269/EU and DIN 70020 (with the car to standard specification). This standard also specifies the permitted tolerances. Additional equipment (optional extras) can have a significant effect on performance and consumption, since it usually increases the car's weight and causes the aerodynamic drag coefficient (c_x) to deteriorate (for instance roof racks, wider tyres, additional mirrors etc.).

		BMW 840Ci	BMW 850Ci	BMW 850CSi
Length	mm (in)	4780 (188.2)	4780 (188.2)	4780 (188.2)
Width	mm (in)	1855 (73.0)	1855 (73.0)	1855 (73.0)
Height (unladen)	mm (in)	1340 (52.8)	1340 (52.8)	1330 (52.4)
Wheelbase	mm (in)	2684 (105.7)	2684 (105.7)	2684 (105.7)
Front track	mm (in)	1554 (61.2)	1554 (61.2)	1564 (61.6)
Rear track	mm (in)	1562 (61.5)	1562 (61.5)	1554 (61.2)
Min. turning circle	m (ft)	11.5 (37.7)	11.5 (37.7)	11.5 (37.7)

		BMW 840Ci	BMW 850Ci	BMW 850CSi
Unladen weight (incl. driver, ready for road, tank full, excluding optional extras)				
- with 6-speed gearbox	kg (lb)	1855 (4090)	–	1975 (4354)
- with automatic transmission	kg (lb)	1895 (4178)	1955 (4310)	–
Gross weight limit				
- with 6-speed gearbox	kg (lb)	2200 (4850)	–	2340 (5159)
- with automatic transmission	kg (lb)	2240 (4938)	2300 (5071)	–
Front axle load limit	kg (lb)	1100 (2425)	1140 (2513)	1150 (2535)
Rear axle load limit	kg (lb)	1190 (2623)	1195 (2635)	1230 (2712)
Trailer loads (according to manufacturer's directives and as legally authorized in Germany) BMW Service can supply information on permissible increases. Note and comply with different values in certain countries.				
Unbraked	kg (lb)	750 (1653)	750 (1653)	–
Braked, max. gradient 12%	kg (lb)	1675 (3693)	1675 (3693)	–
Braked, max. gradient 8%	kg (lb)	1875 (4134)	1875 (4134)	–
Please consult BMW Service if you wish to tow a heavier trailer.				
Trailer nose weight	kg (lb)	75 (165)	75 (165)	–
Roof load limit	kg (lb)	75 (165)	75 (165)	75 (165)
Neither axle load nor gross weight limits must be exceeded.				
Luggage capacity acc. to VDA test	l (cu. ft)	320 (11.3)	320 (11.3)	320 (11.3)

		BMW 840Ci	BMW 850Ci	BMW 850CSi
Top speed				
- with 6-speed gearbox	km/h (mile/h)	250 (155) governed	-	250 (155) governed
- with automatic transmission	km/h (mile/h)	250 (155) governed	250 (155) governed	-
Acceleration				
from 0 - 50 km/h (0 - 31 mile/h)	s	2.5 (2.9)	(2.6)	2.5
0 - 80 km/h (0 - 50 mile/h)	s	4.7 (5.2)	(4.6)	4.6
0 - 100 km/h (0 - 62 mile/h)	s	6.6 (7.1)	(6.3)	6.0
0 - 120 km/h (0 - 75 mile/h)	s	8.8 (9.6)	(8.5)	8.2
80 - 120 km/h in 4th gear	s	6.9	-	5.9
Standing-start kilometre	s	26.2 (27.3)	(26.1)	25.5

Values in brackets (): with automatic transmission

	Litres (Imp. units)	Note
Fuel tank - incl. reserve of	app. 90 (19.8 gal) app. 10 (2.2)	Fuel grade: Page 23
Windscreen washer Headlight cleaning system	app. 2.5 (4.4 pints) app. 9.0 (15.8 pints) - BMW 840Ci, 850Ci	For further details, see Page 101
Models with ARK (filler located in luggage compartment) Intensive cleaning system	app. 4.5 (7.9 pints) app. 1.0 (1.8 pints)	
Cooling system, incl. heater circuit	12.0 (21.1 pints) - BMW 840Ci 13.0 (22.9 pints) - BMW 850Ci, 850 CSi	For further details, see Page 100
Engine incl. oil filter renewal	7.5 (13.2 pints) - BMW 840Ci 8.0 (14.1 pints) - BMW 850Ci 8.25 (14.5 pints) - BMW 850CSi	Brand-name HD oil for spark-ignition engines Oil grades: Page 97
Manual gearbox	1.75 (3.1 pints) - BMW 840Ci 2.3 (4.1 pints) - BMW 850CSi	ATF (information on correct grades from BMW Service)
Automatic transmission	- - BMW 850CSi	ATF (BMW service points are familiar with the correct grades) Permanently filled, no oil changes needed. Apart from inspection work, there are no plans for oil level checks to avoid incorrect fluid levels. Contact BMW Service in exceptional cases
Final drive	1.9 (3.3 pints) - BMW 840Ci, 850Ci 2.7 (4.8 pints) - BMW 850CSi	Brand-name hypoid gear oil (information on correct grades from BMW Service)

Batteries in luggage compartment

2 x 12 Volt, 65 Amp/h

Spark plugs

- BMW 840Ci
Double-earth electrode:
Bosch F7 LDCR or NGK BKR 6 EK
- BMW 850Ci
Double-earth electrode:
F9 LCR
- BMW 850CSi
Double-earth electrode:
Bosch F8 LCR2

V-belts

BMW 840Ci

- Water pump, alternator and power steering
Ribbed 7 K x 1629
- Air conditioning compressor
Ribbed, 5K x 1007

BMW 850Ci

- Alternator and power steering
Ribbed 7 K x 1035
- Water pump and air conditioning
Ribbed 5 K x 1165
- Water pump, air conditioning and second alternator
Ribbed 5 K x 1190
- Second alternator
Ribbed 3 K x 590

BMW 850CSi

- Alternator and power steering
Ribbed 6 K x 1080
- Water pump and air conditioning
Ribbed 6 K x 1195
- Water pump, air conditioning and second alternator
Ribbed 5 K x 1190
- Second alternator
Ribbed 3 K x 590

From A to Z

From A to Z 154

Important facts in brief

Controls

Operating hints

Care and maintenance

Technical data

Index

Overview

Controls

Operation

Maintenance

Data

Keyword

A

ABS (antilock brake system) 17, 127
 Acceleration 150
 Active Rear Axle Kinematics (ARK) 17, 129
 Adaptive Transmission Control (AGS) 71
 Adding engine oil 96
 Aerial 89
 AGS (Adaptive Transmission Control) 71
 Air conditioning 79
 Airbag restraint system 17, 44, 45
 Airbag safety instructions 45
 Alarm system 34, 35
 Alternator 152
 Antifreeze 122
 Anti-lock brake system (ABS) 127
 Approved wheels and tyres 135
 ARK (Active Rear Axle Kinematics) 17, 129
 ASC (Automatic Stability Control) 16
 ASC+T (Automatic Stability Control plus Traction) 73
 Ashtrays 84
 Aspherical wide-angle mirror 40

Automatic air conditioning 76
 Automatic anti-glare inside mirror 41
 Automatic interior light 47
 Automatic Stability Control (ASC) 16
 Automatic Stability Control plus Traction (ASC+T) 73
 Automatic transmission fluid content 151
 Automatic transmission with STEPTRONIC 69
 Average fuel consumption 58
 Average speed 58
 Axle load limits 149

B

Batteries 32, 104, 152
 Battery acid level 104
 Battery charge 16
 Battery charge telltale 15
 Battery charging 105
 Brake fluid 99
 Brake hydraulics 17
 Brake lights failed 64
 Brake pads 65
 Brake servo out of action 64
 Brakes 22, 103, 122
 Brakes, running in 22
 Bulb changing 117

C

Car phone 89
 Car radio operation 89
 Car wash 140
 Caravan towing, see Towing a trailer 123
 Carbon dioxide (CO₂) emissions 147
 Care of special parts 141
 Care of the car 139
 Catalytic converter overheated 65
 Catalytic-converter cars 88
 Cavity protection 139
 Central locking 27
 Changing a wheel 111
 Chassis number, see Vehicle identification number 91
 Check Control 64
 Checking brake fluid 64
 Checking engine oil level 96
 Child restraint systems 43
 Cigarette lighter 84
 Clock 54
 CO₂ emissions 147
 Code, see Immobiliser 62
 Compression ratio 146
 Convenient opening/closure 50
 Convenient operation of sunroof 51
 Convenient window operation 50

Coolant 100

Coolant thermometer 19
 Cooling system 100
 Cooling system capacity 151
 Corrosion protection 139
 Cruise control 72

D

Date display, see Digital clock 54
 Daytime lights 45, 118
 Deadlock, operation from door lock 27
 Deadlocks, operating with radio remote control 30
 Differential, see Final drive 151
 Digital clock 54
 Dimensions 148
 Dipped headlight failure 65
 Dipped headlights 46, 117
 Disc brakes 130
 Displacement 146
 Distance from destination 58
 Distance recorder 18
 Door lock heating 28
 Door locks 27
 Door locks, care in winter 122
 Doors 27
 Driver's airbag 44
 Driver's door lock heating 28
 Driving 130

From A to Z

Driving area 12
 Driving hints 88
 DSC (Dynamic Stability Control) 16, 74
 Dust caps, tyre valves 133
 Dynamic Stability Control (DSC) 16, 74

E

EDC (Electronic Damping Control) 73
 Electric mirror heating 40
 Electric outside mirrors 40
 Electric sunblind 83
 Electric windows 50
 Electrical system 152
 Electronic Damping Control (EDC) 73
 Electronic engine output control (EML) 16
 EML (electronic engine output control) 16, 68
 Engine compartment 92, 93, 94
 Engine compartment lid 90
 Engine compartment light 90
 Engine data 146
 Engine oil 96, 97
 Engine oil content 151
 Engine oil dipstick 96
 Engine oil level check 96
 Engine oil pressure 16

F

Fasten seat belt 16
 Filling capacities 151
 Final drive 151
 Fire extinguisher 107
 First aid kit 108
 Flashers, see Turn indicators 46
 Flashing turn indicator repeaters 16
 Flat battery 110
 Fog light failure 65
 Fog light switches 46
 Fog lights 16, 46, 117
 Folding rear seat backs 85
 Footwell lights 47
 Fuel 23
 Fuel consumption 147
 Fuel filler flap 114
 Fuel gauge 15, 19
 Fuel tank 151
 Fuses 106

G

Gearbox oil content 151
 Gearbox, see Manual gearbox 68
 Generator, see Alternator 152
 Glove box 83

H

Hand lamp 83
 Handbrake 17, 67
 Hazard warning flashers 47
 Head restraints 36
 Headlight beam throw adjustment 48
 Headlight flasher 118
 Headlights 115
 Headlights, opposite rule of the road 126
 Heated rear window 81
 Heated windscreen washer jets 49
 Heating, see automatic air conditioning 78
 Height 148
 High beam headlights 16, 118
 Hydraulics 98

I

Ignition/starter switch 20
 Immobiliser 26, 62
 Independent heater 60
 Independent ventilation control 60
 Initialising remote control 33
 Inside mirror 41
 Instrument cluster 14
 Instrument lighting 46
 Intensive cleaning system 101

Interchanging wheels and tyres 132
 Interior lights 31, 47

J

Jack 111

K

Key with radio remote control 30
 Keys 26

L

Laying up out of use 144
 Leather, care of 143
 LED (light-emitting diodes) 136
 Left seat back, checking 65
 Length 148
 Licence plate lights 120
 Licensing abroad 127
 Light switch 45
 Light-emitting diodes (LED) 136
 Lights on 66
 Luggage capacity 149
 Luggage compartment 29, 115
 Lumbar support 37

M

Maintenance System 138
 Make-up mirror 41

Manual gearbox 68
 Master key 31
 Master key,
 remote control 26
 Memo function 54
 Micro-filter 81
 MID (Multi-Information
 Display) 52
 Mirrors 40, 41
 Modifications, technical 136
 Multi-Information Display
 (MID) 52

N

Number plate light 65

O

Octane number 23
 Oil content, gearbox 151
 Oil dipstick 96
 Oil grades 97, 151
 Oil, capacities 151
 On-board computer 56
 Outside mirrors 40
 Outside temperature display
 57

P

Paintwork, protecting 140
 Paintwork, touching in 141
 Parking lights 46, 118
 Passenger's airbag 44

Passenger's side mirror tilt-
 down 40
 Performance 150
 Pop-up headlights 115, 117
 Pop-up headlights,
 automatic cleaning 49
 Position memory for seats,
 mirrors and steering wheel
 42
 Power output 146
 Power steering 103
 Power steering fluid,
 checking 65
 Punctures 111

R

Radio aerial 89
 Radio remote control 30
 Range before refuelling 57
 Reading lights 47
 Rear fog light 16, 46
 Rear fog light failure 65
 Rear light failure 65
 Rear lights 119
 Recirculated-air mode 80
 Refuelling 15, 23
 Registration abroad 127
 Remote control of on-board
 computer 63
 Retreaded tyres 132
 Reverse 68
 Reversing lights 68

Revolution counter 15, 18
 Right seat back, checking 65
 Rims, see Wheel sizes 135
 Roller blind 83
 Roof load limit 149
 Roof rack 126
 Rubber parts 141
 Rule of the road 126
 Running in 22

S

Seat - lumbar support 37
 Seat adjustment 36
 Seat back lock, checking 65
 Seat back release 38
 Seat belts 42
 Seat belts, care of 42, 141
 Seat heating 37
 Seats 36
 Selector lever 69
 Service Interval indicator 53
 Side light failure 65
 Side lights 45, 118
 Ski bag 85
 Sliding/tilt roof 51, 115
 Snow chains 122, 135
 Spare wheel 111
 Spark plugs 152
 Speed limit (LIMIT) 59
 Speed limit warning 59
 Speedometer 15
 Speeds 150

Sport seats 36
 Starting 21
 Starting aids 110
 Starting the engine 21
 Starting with a flat battery
 110
 Steering hydraulics 17
 Steering lock 20
 Steering wheel adjustment
 38, 39
 Steering wheel adjustment,
 electric 39
 Steering wheel position
 memory 42
 Stopping the engine 21
 Stopwatch 60
 Sun visors 41

T

Technical modifications 136
 Telephone 89
 Telltale 16
 Telltale lights 16
 Temperature, coolant, see
 Coolant thermometer 19
 Thieftproof wheel studs 114
 Toolkit 107
 Tools 107
 Top speed 150
 Torch, see Hand lamp 83
 Torque 146
 Towing a trailer 123

Towing away 109
 Tow-starting 109
 Tow-starting and towing
 away 108
 Track 148
 Trailer load limit 149
 Trailer nose weight 124
 Trailer turn indicators 17
 Transmission emergency-run
 program 65
 Trip distance recorder 15, 18
 Turn indicators 16, 46, 118,
 119
 Turning circle 148
 Type plate 91
 Tyre damage 131
 Tyre markings 133
 Tyre pressures 24, 131
 Tyre sizes 135
 Tyre tread 131
 Tyres 22, 131

U

Underseal 139
 Upholstery care 142

V

V-belts 152
 Vehicle identification number
 91
 Ventilation, see automatic air
 conditioning 76

W

Warning lights 16
 Warning triangle 107
 Washer and cleaning system
 fluid 101
 Washer fluid level 65
 Washer jets 102
 Weight 149
 Weight, gross 149
 Weights 149
 Wheel sizes 135
 Wheel stud wrench 113
 Wheel studs, lockable,
 see Thieftproof wheel
 studs 114
 Wheelbase 148
 Wheels 133
 Wheels and tyres 133
 Width 148
 Windows, demisting 79
 Windscreen washer 48, 101
 Windscreen washer jets 102
 Winter operation 122
 Winter tyres 134
 Wiper blades,
 renewing 116
 Wipers 48
 Wipers, care of 141

